

Ogi A

descriptif technique



.mdd

MDD, créée en 1993 à Sępólno Krajeńskie en Pologne, est d'abord une histoire d'amitié entre Jaroslaw DABROWSKI et Zbigniew MATTYA.

Depuis l'origine, nous souhaitons incarner un modèle d'entreprise où l'humain est la première des préoccupations. Nous considérons que l'épanouissement personnel de chaque membre de notre équipe, est la clé de notre succès. Garder comme piliers des valeurs familiales participe à ce projet.

Nous créons du mobilier répondant aux besoins spécifiques des espaces de travail. Pour vous permettre de favoriser le travail collaboratif, la créativité et les échanges dans l'entreprise, nous vous proposons un mobilier design, conçu PAR et POUR l'homme. Grâce à notre politique de réinvestissement constant dans l'outil de production nous disposons d'un parc de machines modernes, permettant une fabrication de qualité. Citoyens du monde, nous agissons aujourd'hui en pensant aux générations de demain. Ainsi nous utilisons des matériaux au taux de recyclabilité proche de 95%.

Le monde du travail est en mutation constante. Nous veillons, et collaborons avec des designers et nos clients, pour anticiper et être toujours au plus près du besoin.



Informations générales :

Garantie :

Produits MDD - **5 ans**.

Composants électriques et tissus - **2 ans**.

Méla miné - certifié :



Montage :

livrée en pièces détachées

Emballage :

carton, enveloppe en plastique perforé

Conforme aux normes :

PN-EN 527-2:2017-02

Densité du panneau :

12 mm - 690 - 750 kg/m³

18 mm - 650 - 690 kg/m³

28 mm - 610 - 630 kg/m³

36 mm - 610 - 630 kg/m³

Plateaux bureaux Ogi

1. Plateau - mélaminé 28 mm, chants ABS

OPTION PAYANTE:

2. Obturateurs - 2 pcs, Ø 80 mm

3. Mediabox M04H - 2xRJ45 (classe E, cat. 6); 1xUSB/1xHDMI/4x230V, couleur: M009 - aluminium semi-mate

4. Mediabox M04 - 2xRJ45 (classe E, cat. 6); + 1 x USB + 4 x 230V, couleur: M009 - aluminium semi-mate

5. Top access M05 - couleur: M009 - aluminium semi-mate

6. Passage de câbles - la largeur de l'ouverture est proportionnelle à la largeur du plan de travail

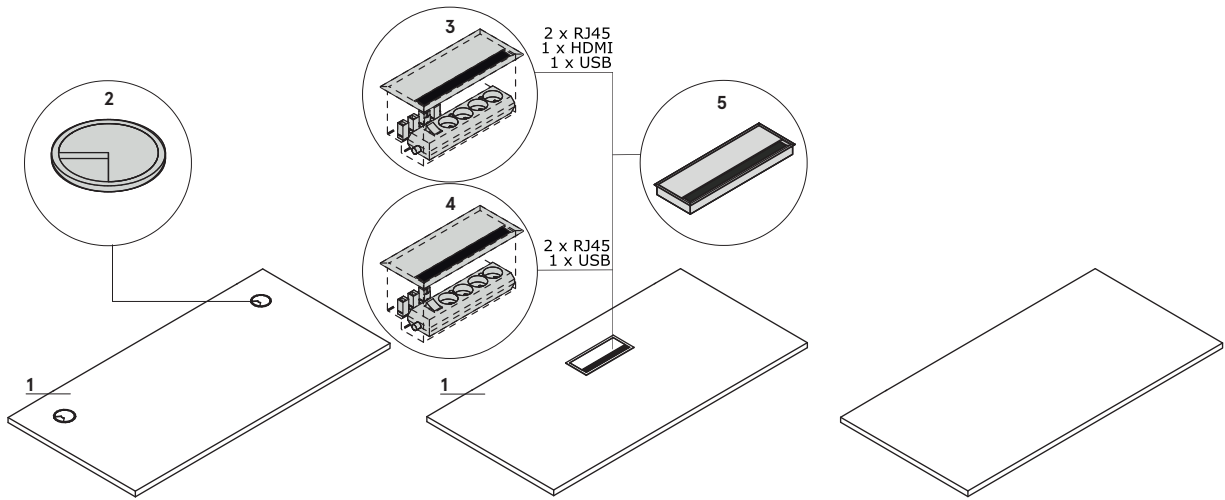

Dimensions des surfaces de travail (mm)

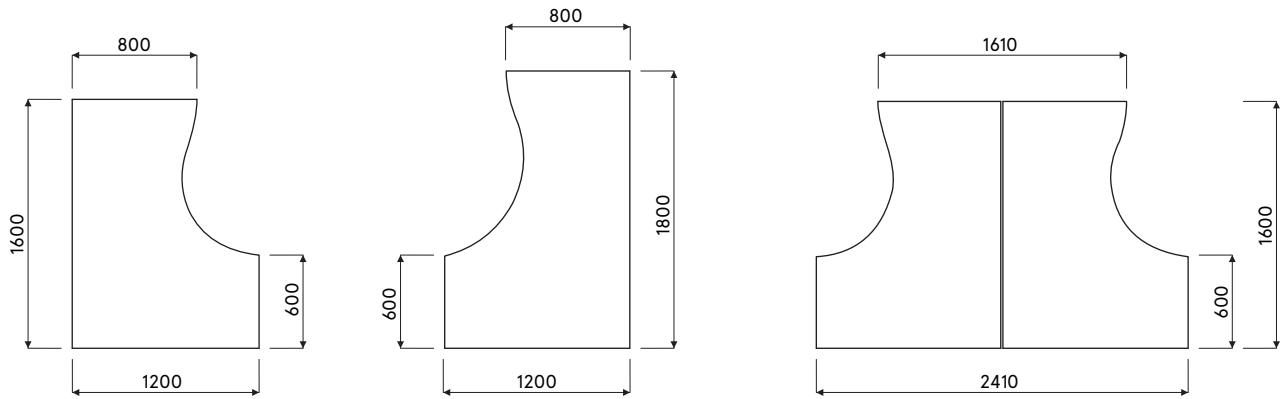

Piétement

Ogi A: métal peinture poudre époxy, profil 60x30 mm

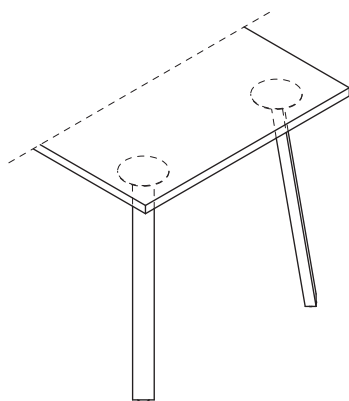

Accessoires

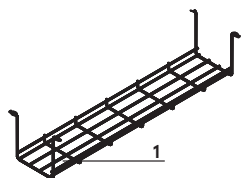

1. **Chemin de câbles S69** - métal finition peinture poudre époxy, couleur 09 - aluminium
2. **Chemin de câbles (SG12, SG16)** - pour bureau individuel, métal finition peinture poudre époxy, couleur M009 - aluminium semi-mate
3. **Chemin de câbles E64** - métal finition peinture poudre époxy, couleur M009 - aluminium semi-mate
4. **Chemin de câbles pour bench Ogi (SG220, SG260)** - fil acier Ø4 mm, métal finition peinture poudre époxy, couleur : 09 - aluminium

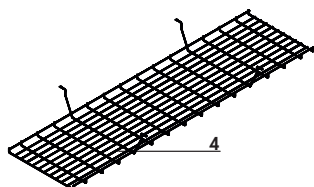
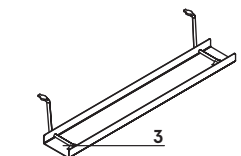
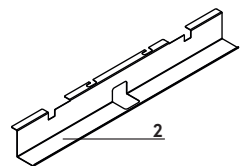

Bureaux droits



BAG026
1200 / 600 / 740
25 kg



BAG036
1400 / 600 / 740
26 kg



BAG046
1600 / 600 / 740
27.6 kg



BAG027
1200 / 700 / 740
24 kg



BAG037
1400 / 700 / 740
27 kg



BAG047
1600 / 700 / 740
29 kg



BAG028
1200 / 800 / 740
27 kg



BAG038
1400 / 800 / 740
29 kg



BAG048
1600 / 800 / 740
32 kg

www.mdd.eu

Bureaux compacts

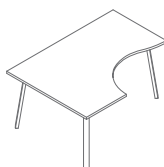

BAG10
1600 / 1200 / 740
37 kg

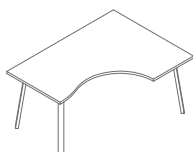

BAG11
1600 / 1200 / 740
37 kg

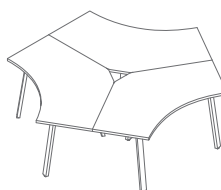

BAG12
2343 / 2029 / 740
93.6 kg

Benches

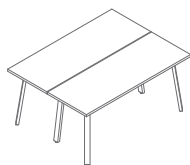

BAG0214
1600 / 1210 / 740
48 kg

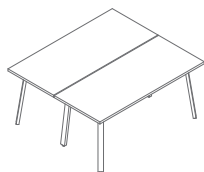

BAG0216
1600 / 1410 / 740
54 kg

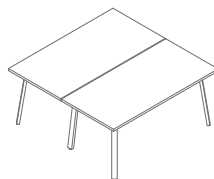

BAG0218
1600 / 1610 / 740
60 kg

Élément suivant - pour multiplier les postes

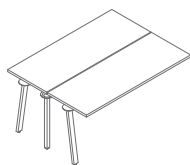

BAG0414
1600 / 1210 / 740
42 kg

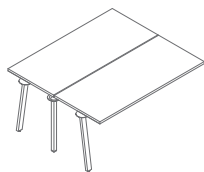

BAG0416
1600 / 1410 / 740
48 kg

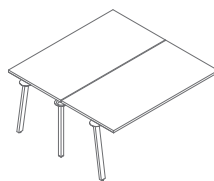

BAG0418
1600 / 1610 / 740
54 kg

Plateau



14 Hêtre * 26 Aluminium satiné 31 Chêne canadien * 39 Bouleau clair *

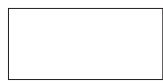

67 Blanc pastel



34 Wengé * 64 Cacao * 106 Noyer * 154 Anthracite



08 Noir

Passes câbles

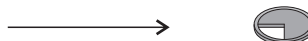

Aluminium

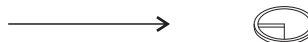

Blanc

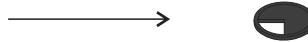

Noir

Piètement - métal



M009 Aluminium semi-mat RAL9006 M015 Blanc semi-mat RAL9010 M154 Anthracite semi-mat RAL7043 M115 Noir semi-mat RAL9005

* corps - groupe II

Ogi M

descriptif technique



.mdd

MDD, créée en 1993 à Sępólno Krajeńskie en Pologne, est d'abord une histoire d'amitié entre Jaroslaw DABROWSKI et Zbigniew MATTYA.

Depuis l'origine, nous souhaitons incarner un modèle d'entreprise où l'humain est la première des préoccupations. Nous considérons que l'épanouissement personnel de chaque membre de notre équipe, est la clé de notre succès. Garder comme piliers des valeurs familiales participe à ce projet.

Nous créons du mobilier répondant aux besoins spécifiques des espaces de travail. Pour vous permettre de favoriser le travail collaboratif, la créativité et les échanges dans l'entreprise, nous vous proposons un mobilier design, conçu PAR et POUR l'homme. Grâce à notre politique de réinvestissement constant dans l'outil de production nous disposons d'un parc de machines modernes, permettant une fabrication de qualité. Citoyens du monde, nous agissons aujourd'hui en pensant aux générations de demain. Ainsi nous utilisons des matériaux au taux de recyclabilité proche de 95%.

Le monde du travail est en mutation constante. Nous veillons, et collaborons avec des designers et nos clients, pour anticiper et être toujours au plus près du besoin.



Informations générales :

Garantie :

Produits MDD - **5 ans**.

Composants électriques et tissus - **2 ans**.

Mélangé - certifié :



Montage :

livrée en pièces détachées

Emballage:

carton, enveloppe en plastique perforé

Conforme aux normes :

PN-EN 527-2:2017-02

Densité du panneau :

12 mm - 690 - 750 kg/m³

18 mm - 650 - 690 kg/m³

28 mm - 610 - 630 kg/m³

36 mm - 610 - 630 kg/m³

Plateaux bureaux Ogi

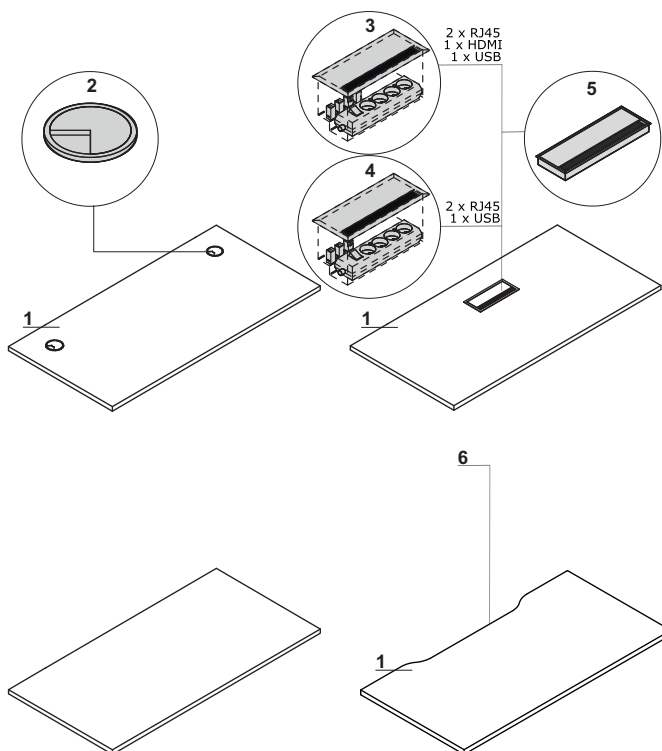

- 1. Plateau - mélaminé 28 mm, chants ABS
- OPTION PAYANTE:
- 2. Obturateurs - 2 pcs, Ø 80 mm
- 3. Mediabox M04H - 2xRJ45 (classe E, cat. 6); 1xUSB/1xHDMI/4x230V, couleur: M009 - aluminium semi-mate
- 4. Mediabox M04 - 2xRJ45 (classe E, cat. 6); + 1 x USB + 4 x 230V, couleur: M009 - aluminium semi-mate
- 5. Top access M05 - couleur: M009 - aluminium semi-mate
- 6. Passage de câbles - la largeur de l'ouverture est proportionnelle à la largeur du plan de travail

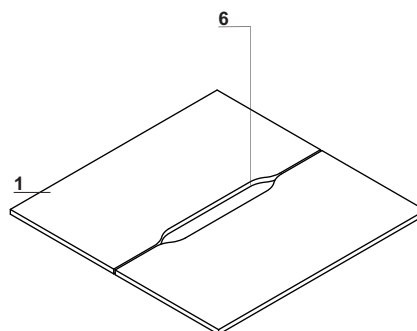

Dimensions du plateau avec découpe pour passage câbles (mm)

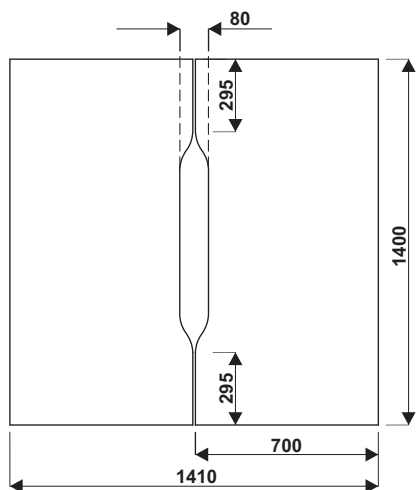

Piètement

Ogi M: métal finition peinture poudre époxy, profil 40 × 40 mm, distance entre le dessus et le cadre de 10 mm

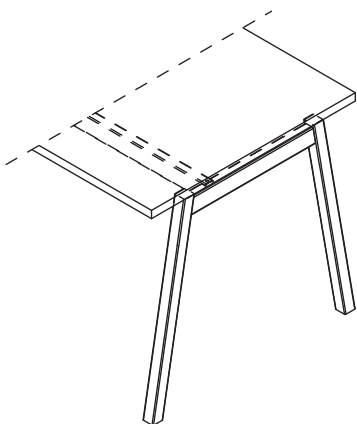

Bureaux manager sur meuble retour porteur

- 1. Plateau - mélaminé 28 mm, chants ABS
- 2. Top - mélaminé 28 mm, chants ABS
- 3. Tablette - mélaminé 18 mm, protection contre les chutes accidentelles, chants ABS
- 4. Tiroir - mélaminé 18 mm; chants ABS, serrure, possibilité de le changer de place
- 5. Base - mélaminé 18 mm, chants ABS
- 6. Façade - mélaminé 18 mm, chants ABS

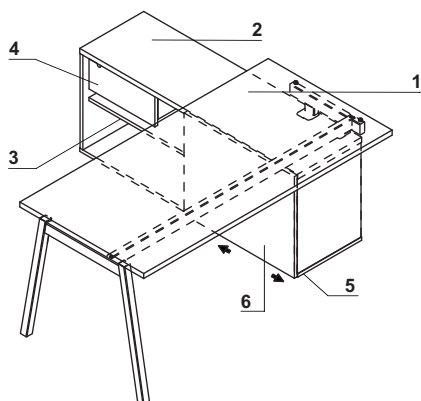

www.mdd.eu

Exemples de configurations (mm)

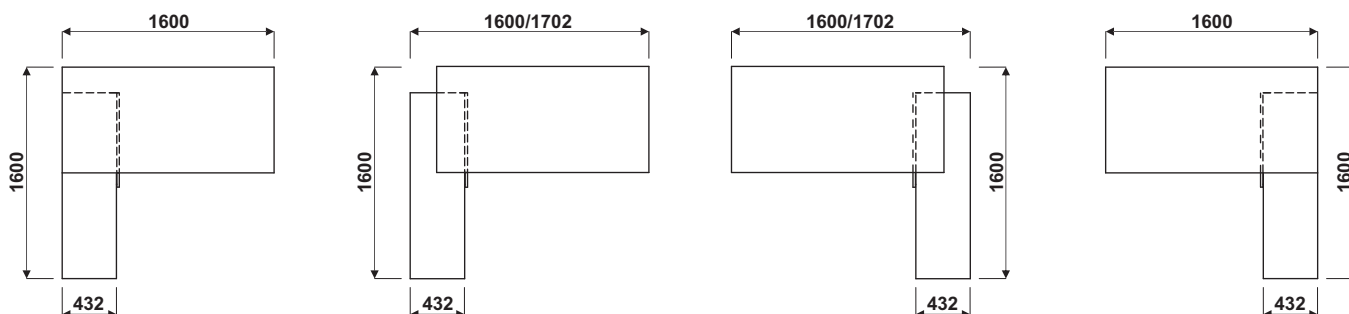

Exemples de configurations (mm)

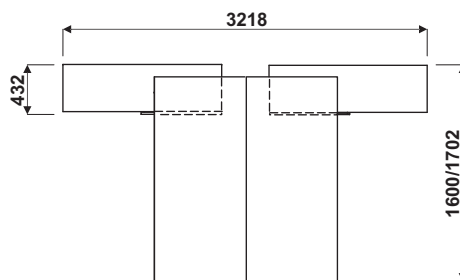
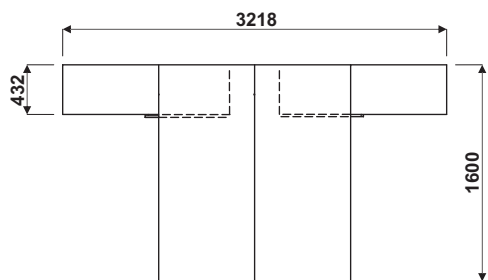

Exemples de configuration avec BOX40, BOX50, BOX60

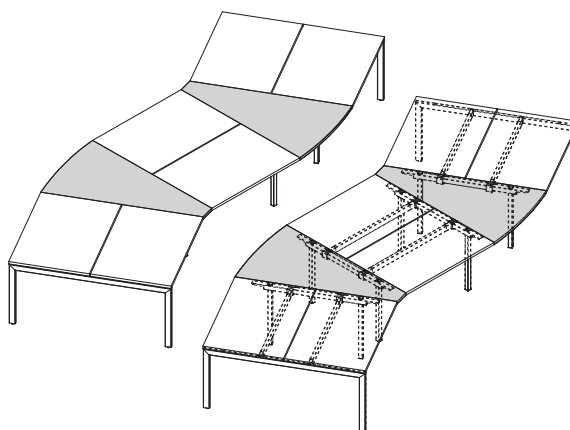
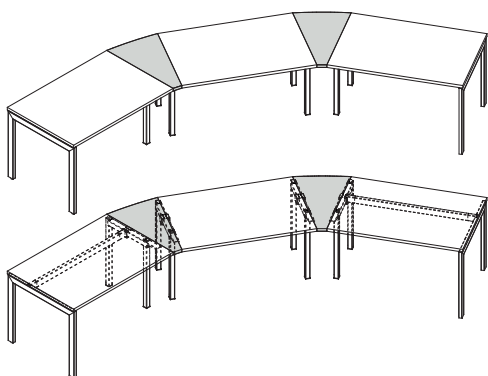

REMARQUE – Uniquement pour les systèmes Ogi Q, Ogi U, Ogi Y, Ogi W, Ogi M

Accessoires

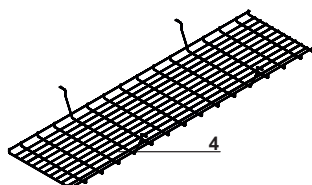
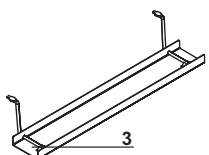
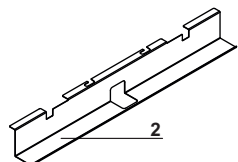
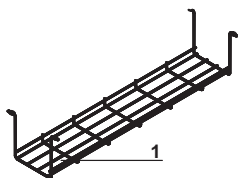

1. **Chemin de câbles S69** - métal finition peinture poudre époxy, couleur 09 - aluminium
2. **Chemin de câbles (SG2, SG16)** - pour bureau individuel, métal finition peinture poudre époxy, couleur M009 - aluminium semi-mate
3. **Chemin de câbles E64** - métal finition peinture poudre époxy, couleur M009 - aluminium semi-mate
4. **Chemin de câbles pour bench Ogi (SG220, SG260)** - fil acier Ø4 mm, métal finition peinture poudre époxy, couleur : 09 - aluminium

Bureaux droits



BOM22
1200 / 700 / 740
29.9 kg



BOM24
1400 / 700 / 740
33.3 kg



BOM26
1600 / 700 / 740
36.9 kg

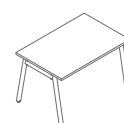

BOM02
1200 / 800 / 740
35.8 kg



BOM03
1400 / 800 / 740
36.3 kg



BOM04
1600 / 800 / 740
36.9 kg



BOM05
1800 / 800 / 740
40 kg



BOM06
2000 / 800 / 740
46.3kg

Élément suivant - pour bureau droit



BOX40
500 / 800 / 740
10.8 kg

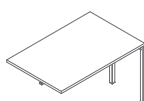

BOX42
1200 / 800 / 740
31.6 kg

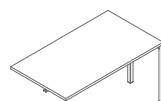

BOX43
1400 / 800 / 740
32.1 kg

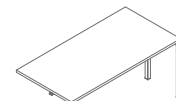

BOX44
1600 / 800 / 740
32.7 kg

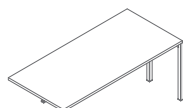

BOX45
1600 / 800 / 740
35.8 kg

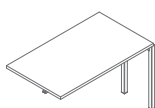

BOX32
1200 / 700 / 740
26.3 kg

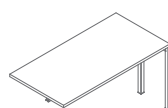

BOX34
1400 / 700 / 740
29.7 kg

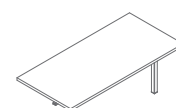

BOX36
1600 / 700 / 740
33.3 kg

Benchs

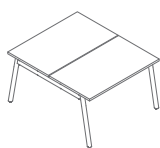

BOM42
1200 / 1410 / 740
54.8 kg

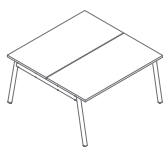

BOM44
1400 / 1410 / 740
61.6 kg

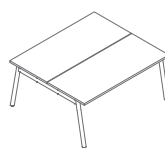

BOM46
1600 / 1410 / 740
68.8 kg

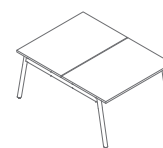

BOM32
1200 / 1610 / 740
65.6 kg

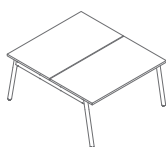

BOM33
1400 / 1610 / 740
66.6 kg

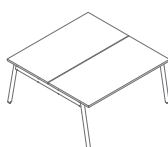

BOM34
1600 / 1610 / 740
67.8 kg

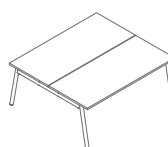

BOM35
1800 / 1610 / 740
74 kg

Élément de jonction et élément suivant - pour bench



BOX50
1000 / 1410 / 740
16.5 kg

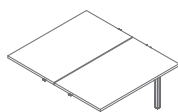

BOX52
1200 / 1410 / 740
49.4 kg

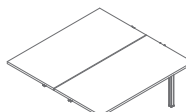

BOX54
1400 / 1410 / 740
56.2 kg

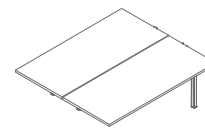

BOX56
1600 / 1410 / 740
63.4 kg

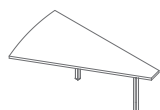

BOX60
1000 / 1610 / 740
17.5 kg

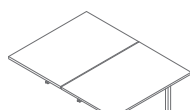

BOX62
1200 / 1610 / 740
60.1 kg

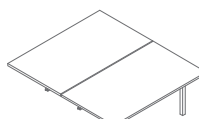

BOX64
1400 / 1610 / 740
61.1 kg

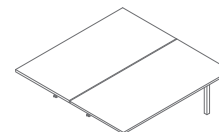

BOX66
1600 / 1610 / 740
62.3 kg

Élément de jonction et élément suivant - pour bench

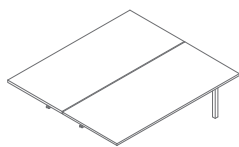

BOX68
1800 / 1610 / 740
68,5 kg

Bureaux sur meuble retour porteur

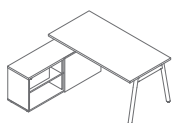

BOM20
1702-1600 / 1600 / 740
93 kg

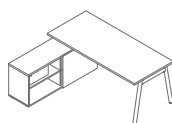

BOM21
1902-1800 / 1600 / 740
94,5 kg

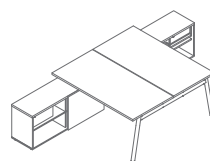

BOM40
1702-1600 / 3210 / 740
179,8 kg

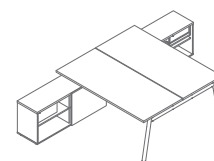

BOM41
1902-1800 / 3210 / 740
186 kg

Retours / extensions

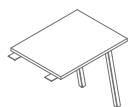

POM01
600 / 800 / 740
13,9 kg

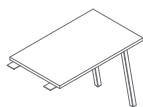

POM02
600 / 1000 / 740
15,4 kg

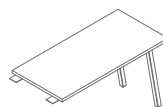

POM03
600 / 1200 / 740
17,9 kg

Plateau, top, base, corps, façade

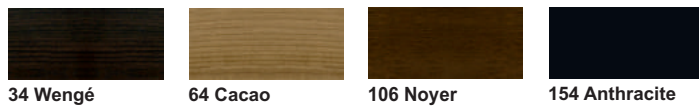
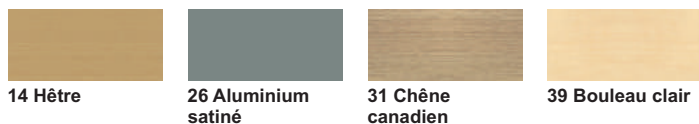

Passes câbles

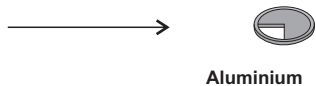

Aluminium

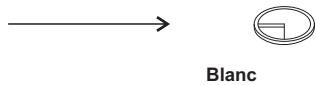

Blanc

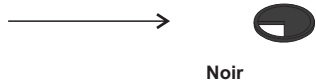

Noir

Piètement - métal

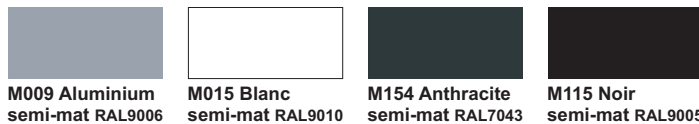

Ogi Q

descriptif technique



.mdd

MDD, créée en 1993 à Sępólno Krajeńskie en Pologne, est d'abord une histoire d'amitié entre Jaroslaw DABROWSKI et Zbigniew MATTYA.

Depuis l'origine, nous souhaitons incarner un modèle d'entreprise où l'humain est la première des préoccupations. Nous considérons que l'épanouissement personnel de chaque membre de notre équipe, est la clé de notre succès. Garder comme piliers des valeurs familiales participe à ce projet.

Nous créons du mobilier répondant aux besoins spécifiques des espaces de travail. Pour vous permettre de favoriser le travail collaboratif, la créativité et les échanges dans l'entreprise, nous vous proposons un mobilier design, conçu PAR et POUR l'homme. Grâce à notre politique de réinvestissement constant dans l'outil de production nous disposons d'un parc de machines modernes, permettant une fabrication de qualité. Citoyens du monde, nous agissons aujourd'hui en pensant aux générations de demain. Ainsi nous utilisons des matériaux au taux de recyclabilité proche de 95%.

Le monde du travail est en mutation constante. Nous veillons, et collaborons avec des designers et nos clients, pour anticiper et être toujours au plus près du besoin.



Informations générales :

Garantie :

Produits MDD - **5 ans**.

Composants électriques et tissus - **2 ans**.

Mélaminé - certifié :



Montage :

livrée en pièces détachées

Emballage :

carton, enveloppe en plastique perforé

Conforme aux normes :

PN-EN 527-2:2017-02

Densité du panneau :

12 mm - 690 - 750 kg/m³

18 mm - 650 - 690 kg/m³

28 mm - 610 - 630 kg/m³

36 mm - 610 - 630 kg/m³

Plateaux bureaux Ogi

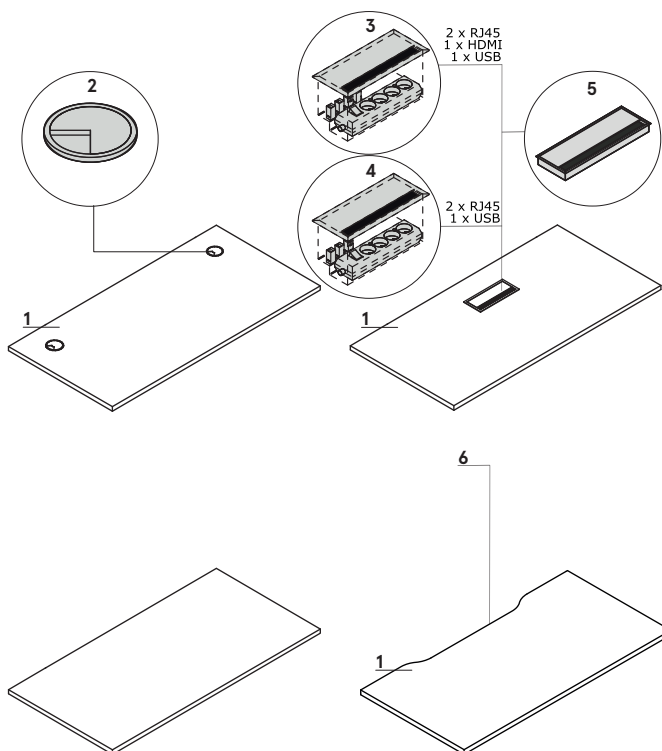

1. Plateau - mélaminé 28 mm, chants ABS

OPTION PAYANTE:

2. Obturateurs - 2 pcs, Ø 80 mm

3. Mediabox M04H - 2xRJ45 (classe E, cat. 6); 1xUSB/1xHDMI/4x230V, couleur: M009 - aluminium semi-mate

4. Mediabox M04 - 2xRJ45 (classe E, cat. 6); + 1 x USB + 4 x 230V, couleur: M009 - aluminium semi-mate

5. Top access M05 - couleur: M009 - aluminium semi-mate

6. Passage de câbles - la largeur de l'ouverture est proportionnelle à la largeur du plan de travail

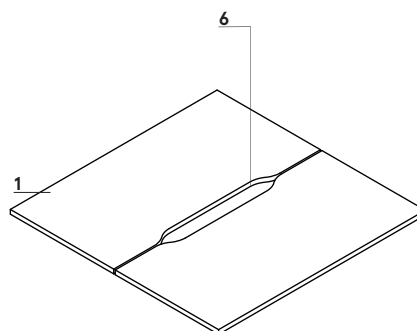

Dimensions du plateau avec découpe pour passage de câbles (mm)

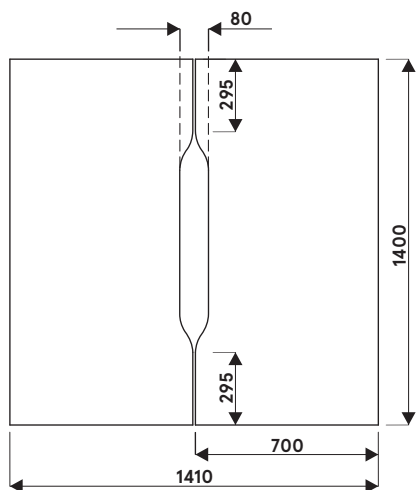

<p>Ogi Q</p>	<p>Date 18.11.2019</p>	<p>Ces données sont valides à la date d'élaboration. Les évolutions des produits, si elles ne touchent pas les caractéristiques fondamentales, n'impliquent pas une mise à jour systématique de la fiche technique.</p>	<p>page 3/9 descriptif et composition</p>
--------------	----------------------------	---	---

Piétement

Ogi Q: métal finition peinture poudre époxy, profil 60x20 mm, entretoise 10 mm

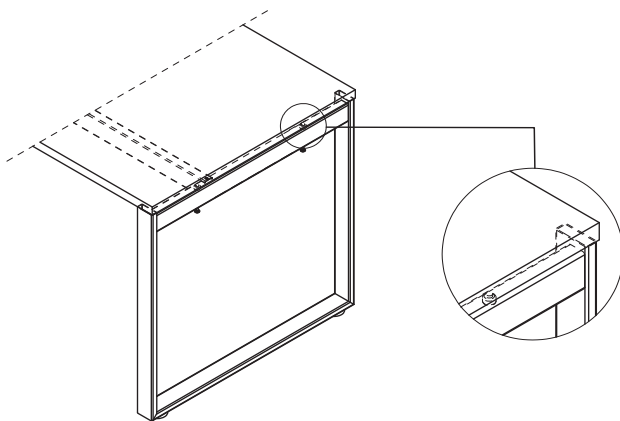

Bureaux manager sur meuble retour porteur

- 1. Plateau - mélaminé 28 mm, chants ABS
- 2. Top - mélaminé 28 mm, chants ABS
- 3. Tablette - mélaminé 18 mm, protection contre les chutes accidentelles, chants ABS
- 4. Tiroir - mélaminé 18 mm; chants ABS, serrure, possibilité de le changer de place
- 5. Base - mélaminé 18 mm, chants ABS
- 6. Façade - mélaminé 18 mm, chants ABS

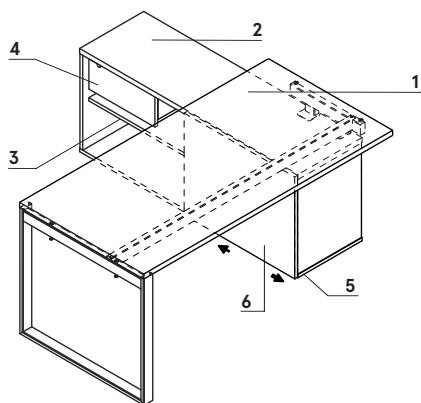

www.mdd.eu

Exemples de configurations (mm)

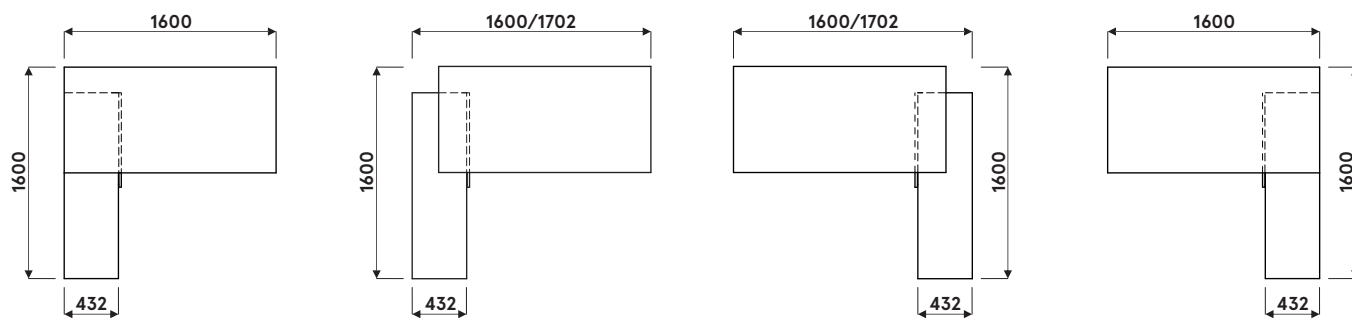

Exemples de configurations (mm)

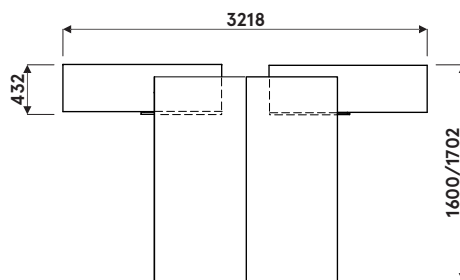
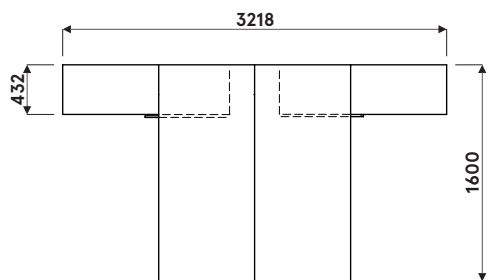

Exemples de configuration avec BOX40, BOX50, BOX60

www.mdd.eu

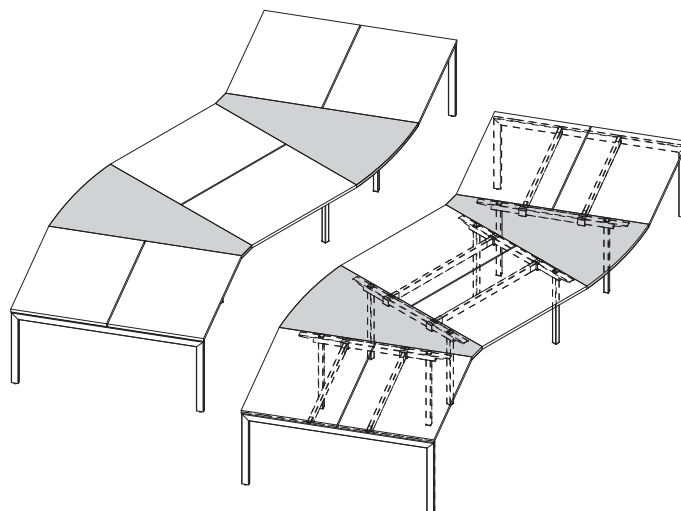
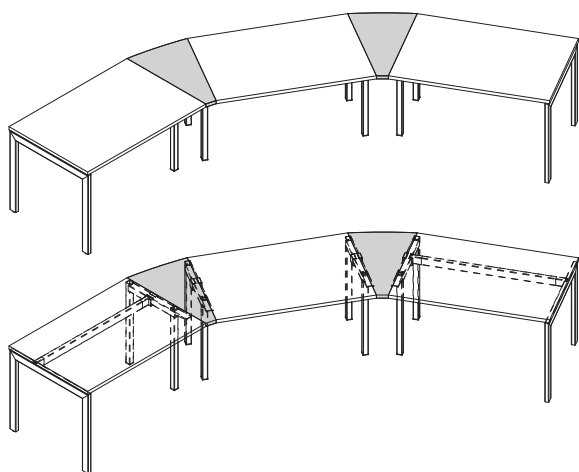

REMARQUE - Uniquement pour les systèmes Ogi Q, Ogi U, Ogi Y, Ogi W, Ogi M

Accessoires

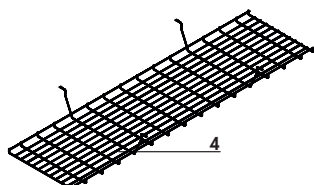
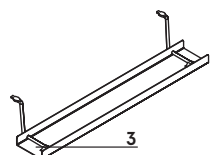
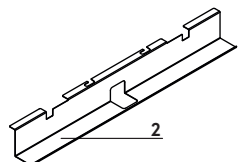
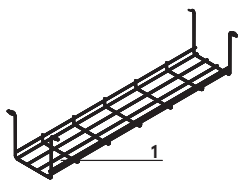

1. **Chemin de câbles S69** - métal finition peinture poudre époxy, couleur 09 - aluminium
2. **Chemin de câbles (SG12, SG16)** - pour bureau individuel, métal finition peinture poudre époxy, couleur M009 - aluminium semi-mate
3. **Chemin de câbles E64** - métal finition peinture poudre époxy, couleur M009 - aluminium semi-mate
4. **Chemin de câbles pour bench Ogi (SG220, SG260)** - fil acier Ø4 mm, métal finition peinture poudre époxy, couleur : 09 - aluminium

Ogi Q	Date 18.11.2019	Ces données sont valides à la date d'élaboration. Les évolutions des produits, si elles ne touchent pas les caractéristiques fondamentales, n'impliquent pas une mise à jour systématique de la fiche technique.	page 5/9 descriptif et composition
-------	--------------------	---	---------------------------------------

Bureaux droits

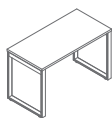

BOQ12
1200 / 600 / 740
31.9 kg

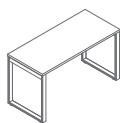

BOQ14
1400 / 600 / 740
35 kg

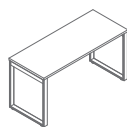

BOQ16
1600 / 600 / 740
38.1 kg

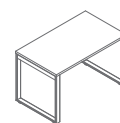

BOQ22
1200 / 700 / 740
35.5 kg

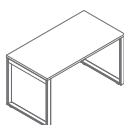

BOQ24
1400 / 700 / 740
38.9 kg

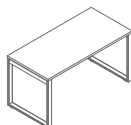

BOQ26
1600 / 700 / 740
42.5 kg

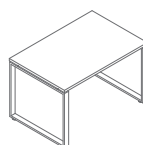

BOQ02
1200 / 800 / 740
41 kg

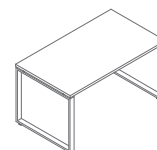

BOQ03
1400 / 800 / 740
41.5 kg

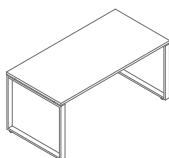

BOQ04
1600 / 800 / 740
42.1 kg

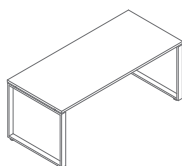

BOQ05
1800 / 800 / 740
45.2 kg

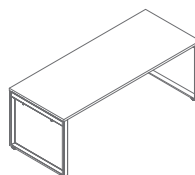

BOQ06
2000 / 800 / 740
51.5 kg

www.mdd.eu

Élément suivant - pour bureau droit



BOX40
500 / 800 / 740
10.8 kg

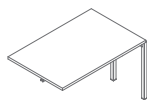

BOX42
1200 / 800 / 740
31.6 kg

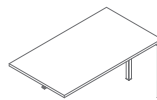

BOX43
1400 / 800 / 740
32.1 kg

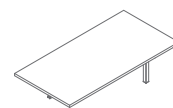

BOX44
1600 / 800 / 740
32.7 kg

Élément suivant - pour bureau droit

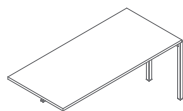

BOX45
1600 / 800 / 740
35.8 kg

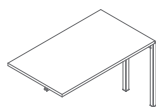

BOX32
1200 / 700 / 740
26.3 kg

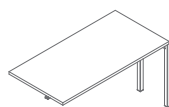

BOX34
1400 / 700 / 740
29.7 kg

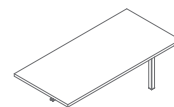

BOX36
1600 / 700 / 740
33.3 kg

Benchs

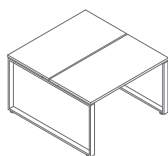

BOQ42
1200 / 1410 / 740
51.9 kg

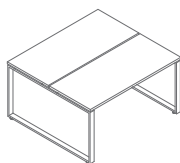

BOQ44
1400 / 1410 / 740
58.7 kg

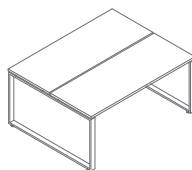

BOQ46
1600 / 1410 / 740
65.9 kg

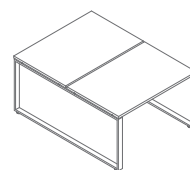

BOQ32
1200 / 1610 / 740
61 kg

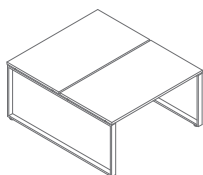

BOQ33
1400 / 1610 / 740
62.6 kg

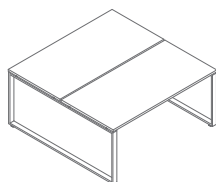

BOQ34
1600 / 1610 / 740
63.8 kg

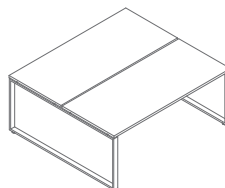

BOQ35
1800 / 1610 / 740
70 kg

Élément de jonction et élément suivant - pour bench

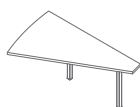

BOX50
1000 / 1410 / 740
16.5 kg

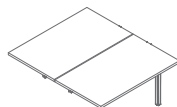

BOX52
1200 / 1410 / 740
49.4 kg

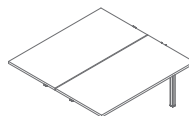

BOX54
1400 / 1410 / 740
56.2 kg

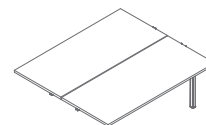

BOX56
1600 / 1410 / 740
63.4 kg

Élément de jonction et élément suivant - pour bench

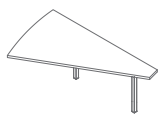

BOX60
1000 / 1610 / 740
17,5 kg

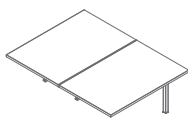

BOX62
1200 / 1610 / 740
60,1 kg

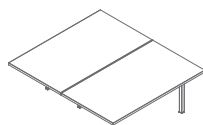

BOX64
1400 / 1610 / 740
61,1 kg

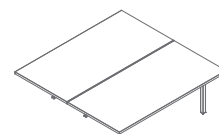

BOX66
1600 / 1610 / 740
62,3 kg

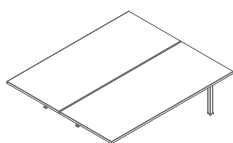

BOX68
1800 / 1610 / 740
68,5 kg

Bureaux sur meuble retour porteur

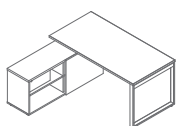

BOQL20
1600-1702 / 1600 / 740
94,4 kg

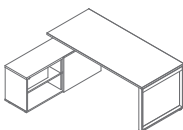

BOQL21
1800-1902 / 1600 / 740
97,5 kg

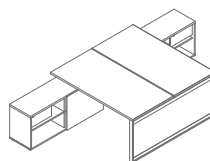

BOQL40
1600-1702 / 3210 / 740
185,8 kg

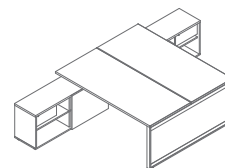

BOQL41
1800-1902 / 3210 / 740
192 kg

Retours / extensions

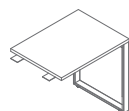

PLQ01
600 / 800 / 740
19,5 kg

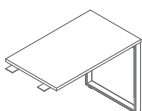

PLQ02
600 / 1000 / 740
20,7 kg

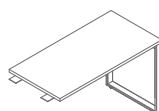

PLQ03
600 / 1200 / 740
23,2 kg

Plateau, top, base, corps, façade



14 Hêtre *

26 Aluminium satiné

31 Chêne canadien *

39 Bouleau clair *

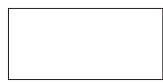

67 Blanc pastel



34 Wengé *



64 Cacao *



106 Noyer 8



154 Anthracite



08 Noir

Passes câbles



Aluminium



Blanc



Noir

Piètement - métal



M009 Aluminium semi-mat RAL9006

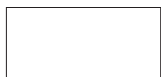

M015 Blanc semi-mat RAL9010



M154 Anthracite semi-mat RAL7043



M115 Noir semi-mat RAL9005

* corps - groupe II

Ogi U

descriptif technique



.mdd

MDD, créée en 1993 à Sępólno Krajeńskie en Pologne, est d'abord une histoire d'amitié entre Jaroslaw DABROWSKI et Zbigniew MATTYA.

Depuis l'origine, nous souhaitons incarner un modèle d'entreprise où l'humain est la première des préoccupations. Nous considérons que l'épanouissement personnel de chaque membre de notre équipe, est la clé de notre succès. Garder comme piliers des valeurs familiales participe à ce projet.

Nous créons du mobilier répondant aux besoins spécifiques des espaces de travail. Pour vous permettre de favoriser le travail collaboratif, la créativité et les échanges dans l'entreprise, nous vous proposons un mobilier design, conçu PAR et POUR l'homme. Grâce à notre politique de réinvestissement constant dans l'outil de production nous disposons d'un parc de machines modernes, permettant une fabrication de qualité. Citoyens du monde, nous agissons aujourd'hui en pensant aux générations de demain. Ainsi nous utilisons des matériaux au taux de recyclabilité proche de 95%.

Le monde du travail est en mutation constante. Nous veillons, et collaborons avec des designers et nos clients, pour anticiper et être toujours au plus près du besoin.



Informations générales :

Garantie :

Produits MDD - **5 ans**.

Composants électriques et tissus - **2 ans**.

Mélangé - certifié :



Montage :

livrée en pièces détachées

Emballage :

carton, enveloppe en plastique perforé

Conforme aux normes :

PN-EN 527-2:2017-02

Densité du panneau :

12 mm - 690 - 750 kg/m³

18 mm - 650 - 690 kg/m³

28 mm - 610 - 630 kg/m³

36 mm - 610 - 630 kg/m³

Plateaux bureaux Ogi

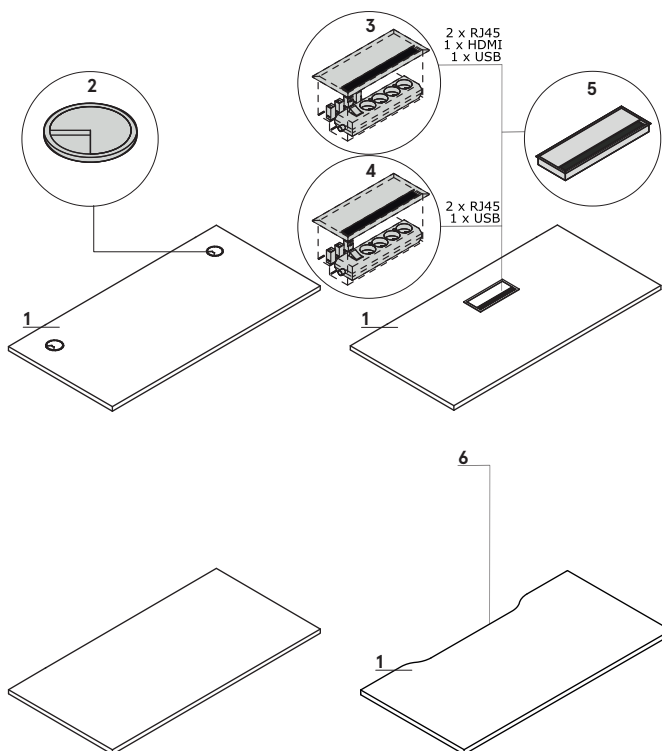

1. Plateau - mélaminé 28 mm, chants ABS

OPTION PAYANTE:

2. Obturateurs - 2 pcs, Ø 80 mm

3. Mediabox M04H - 2xRJ45 (classe E, cat. 6); 1xUSB/1xHDMI/4x230V, couleur: M009 - aluminium semi-mate

4. Mediabox M04 - 2xRJ45 (classe E, cat. 6); + 1 x USB + 4 x 230V, couleur: M009 - aluminium semi-mate

5. Top access M05 - couleur: M009 - aluminium semi-mate

6. Passage de câbles - la largeur de l'ouverture est proportionnelle à la largeur du plan de travail

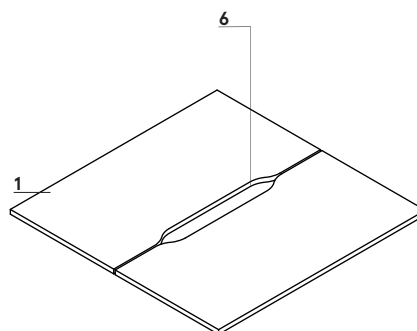

Dimensions des surfaces de travail (mm)

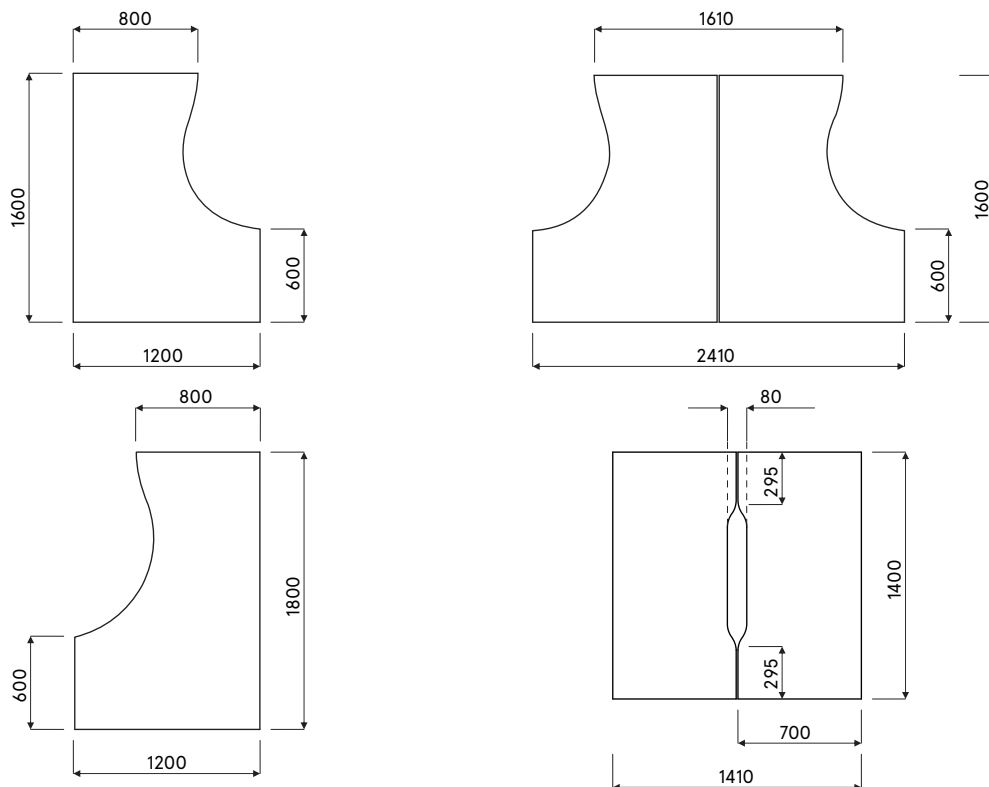

Ogi U	Date 19.11.2019	Ces données sont valides à la date d'élaboration. Les évolutions des produits, si elles ne touchent pas les caractéristiques fondamentales, n'impliquent pas une mise à jour systématique de la fiche technique.	page 3/10 descriptif et composition
-------	--------------------	---	--

Piètement

Ogi U : métal finition peinture poudre époxy, profil 60x30 mm, entretoise 10 mm

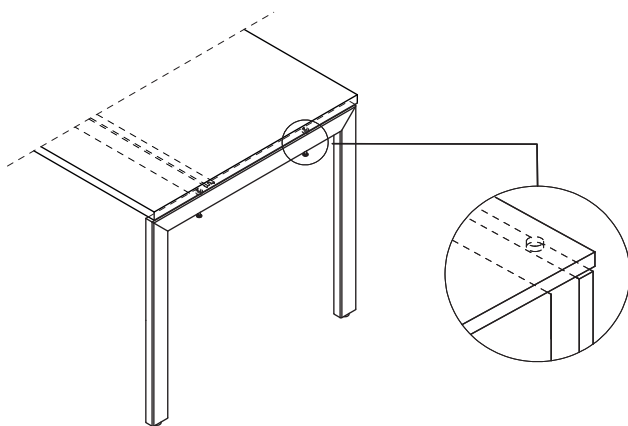

Bureaux manager sur meuble retour porteur

- 1. Plateau - mélaminé 28 mm, chants ABS
- 2. Top - mélaminé 28 mm, chants ABS
- 3. Tablette - mélaminé 18 mm, protection contre les chutes accidentelles, chants ABS
- 4. Tiroir - mélaminé 18 mm; chants ABS, serrure, possibilité de le changer de place
- 5. Base - mélaminé 18 mm, chants ABS
- 6. Façade - mélaminé 18 mm, chants ABS

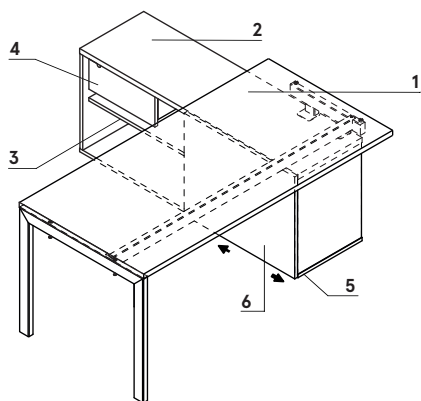

www.mdd.eu

Exemples de configurations (mm)

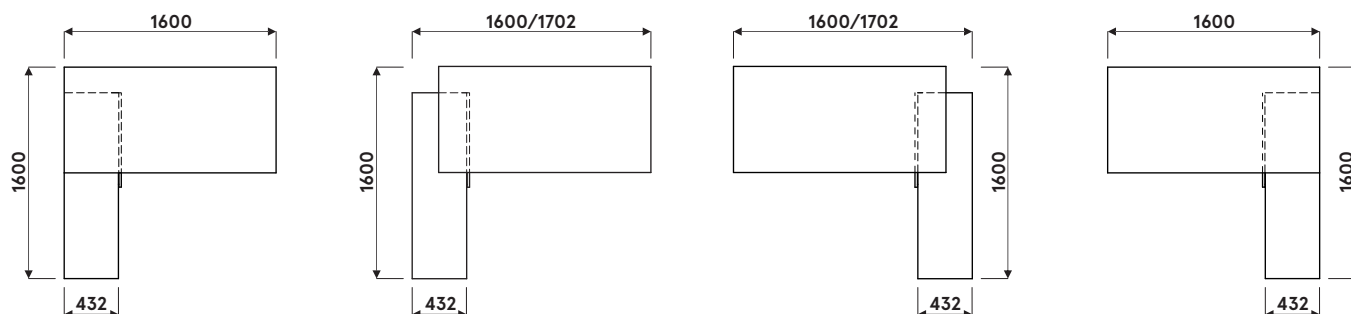

Exemples de configurations (mm)

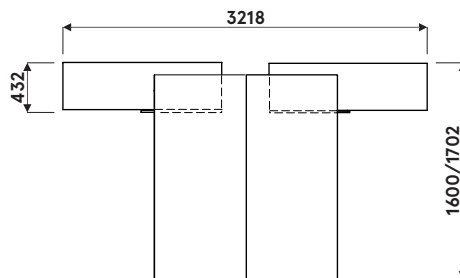
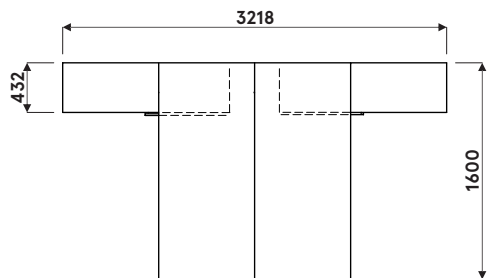

Exemples de configuration avec BOX40, BOX50, BOX60

www.mdd.eu

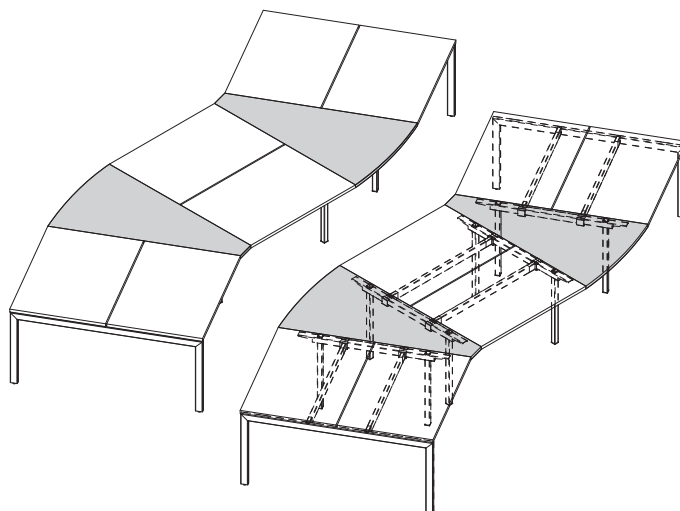
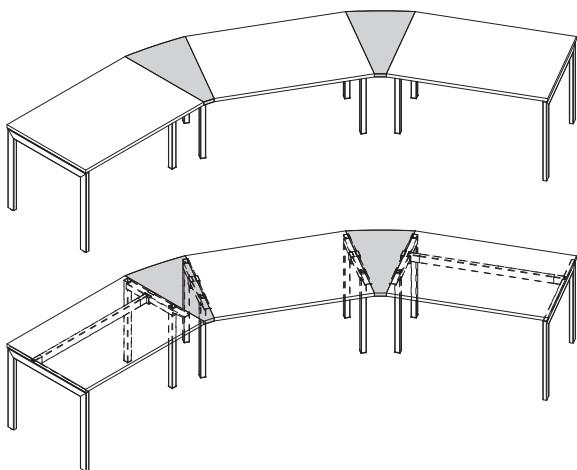

REMARQUE - Uniquement pour les systèmes Ogi Q, Ogi U, Ogi Y, Ogi W, Ogi M

Accessoires

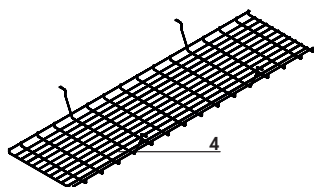
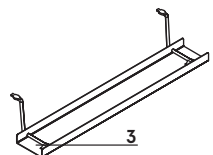
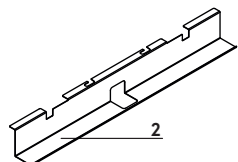
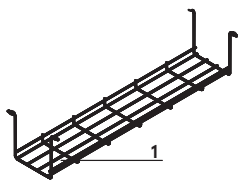

1. **Chemin de câbles S69** - métal finition peinture poudre époxy, couleur 09 - aluminium
2. **Chemin de câbles (SG12, SG16)** - pour bureau individuel, métal finition peinture poudre époxy, couleur M009 - aluminium semi-mate
3. **Chemin de câbles E64** - métal finition peinture poudre époxy, couleur M009 - aluminium semi-mate
4. **Chemin de câbles pour bench Ogi (SG220, SG260)** - fil acier Ø4 mm, métal finition peinture poudre époxy, couleur : 09 - aluminium

Ogi U	Date 19.11.2019	Ces données sont valides à la date d'élaboration. Les évolutions des produits, si elles ne touchent pas les caractéristiques fondamentales, n'impliquent pas une mise à jour systématique de la fiche technique.	page 5/10 descriptif et composition
-------	--------------------	---	--

Bureaux droits



BOU12
1200 / 600 / 740
29.7 kg

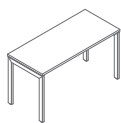

BOU14
1400 / 600 / 740
32.8 kg

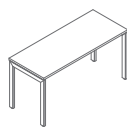

BOU16
1600 / 600 / 740
35.9 kg

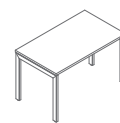

BOU28
1200 / 700 / 740
32.3 kg



BOU29
1400 / 700 / 740
35.7 kg

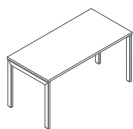

BOU30
1600 / 700 / 740
39.3 kg



BOU19
1200 / 800 / 740
37.8 kg



BOU20
1400 / 800 / 740
38.3 kg

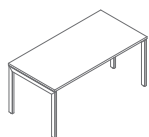

BOU21
1600 / 800 / 740
38.9 kg

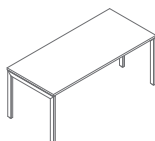

BOU22
1800 / 800 / 740
42 kg

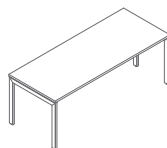

BOU27
2000 / 800 / 740
49.7 kg

www.mdd.eu

Élément suivant - pour bureau droit



BOX40
500 / 800 / 740
10.8 kg

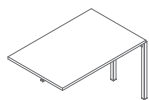

BOX42
1200 / 800 / 740
31.6 kg

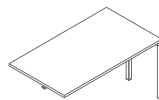

BOX43
1400 / 800 / 740
32.1 kg

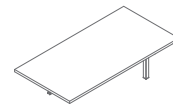

BOX44
1600 / 800 / 740
32.7 kg

Élément suivant - pour bureau droit

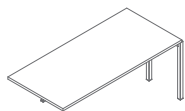

BOX45
1600 / 800 / 740
35.8 kg

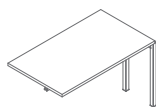

BOX32
1200 / 700 / 740
26.3 kg

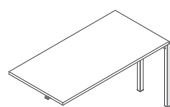

BOX34
1400 / 700 / 740
29.7 kg

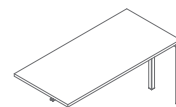

BOX36
1600 / 700 / 740
33.3 kg

Bureaux compacts

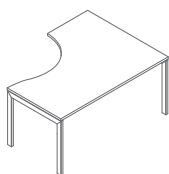

BOU23
1600 / 1200 / 740
46.1 kg

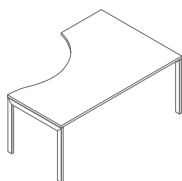

BOU25
1800 / 1200 / 740
42 kg

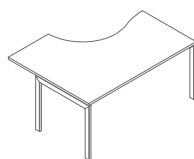

BOU24
1600 / 1200 / 740
46.1 kg

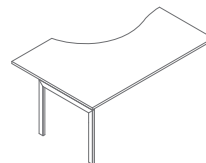

BOU26
1800 / 1200 / 740
44 kg

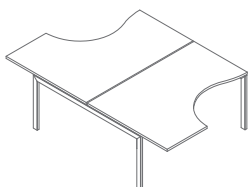

BOU15
1600 / 2410 / 740
85.5 kg

www.mdd.eu

Bureaux sur meuble retour porteur

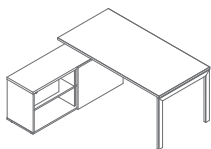

BOUL20
1600-1702 / 1600 / 740
92.9 kg

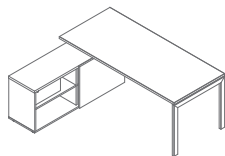

BOUL21
1800-1902 / 1600 / 740
96 kg

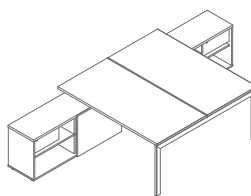

BOUL40
1600-1702 / 3210 / 740
182.6 kg

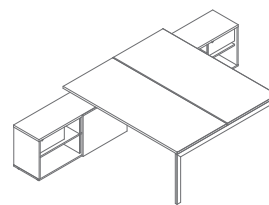

BOUL41
1800-1902 / 3210 / 740
188.8 kg

Benches

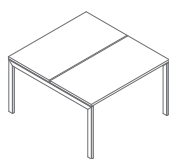

BOU42
1200 / 1410 / 740
57.1 kg

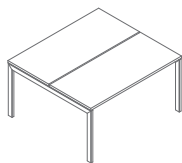

BOU44
1400 / 1410 / 740
63.9 kg

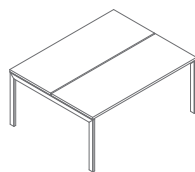

BOU46
1600 / 1410 / 740
71.1 kg

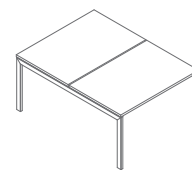

BOU32
1200 / 1610 / 740
68.9 kg

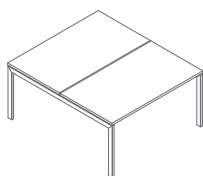

BOU33
1400 / 1610 / 740
69.9 kg

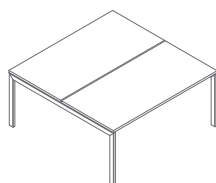

BOU34
1600 / 1610 / 740
71.1 kg

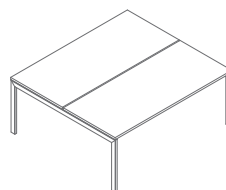

BOU35
1800 / 1610 / 740
77.3 kg

Élément de jonction et élément suivant - pour bench



BOX50
1000 / 1410 / 740
16.5 kg

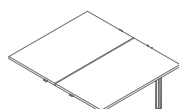

BOX52
1200 / 1410 / 740
49.4 kg

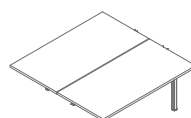

BOX54
1400 / 1410 / 740
56.2 kg

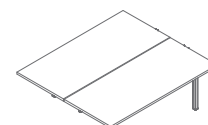

BOX56
1600 / 1410 / 740
63.4 kg

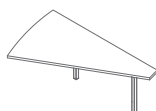

BOX60
1000 / 1610 / 740
17.5 kg

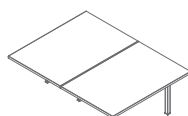

BOX62
1200 / 1610 / 740
60.1 kg

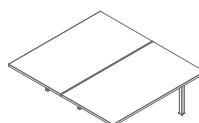

BOX64
1400 / 1610 / 740
61.1 kg

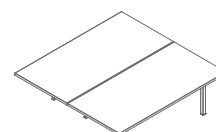

BOX66
1600 / 1610 / 740
62.3 kg

Élément de jonction et élément suivant - pour bench

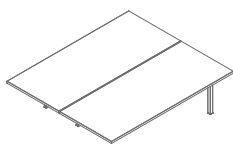

BOX68
1800 / 1610 / 740
68,5 kg

Retours / extensions

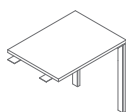

PLU01
600 / 800 / 740
18.4 kg

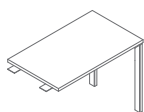

PLU02
600 / 1000 / 740
19.6 kg

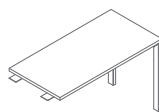

PLU03
600 / 1200 / 740
22.1 kg

Plateau, top, base, corps, façade

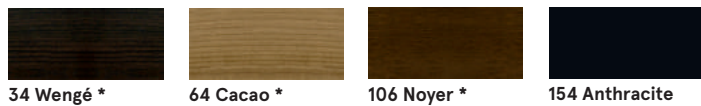

Passes câbles

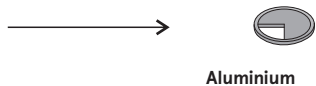

Aluminium

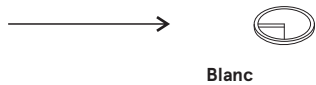

Blanc

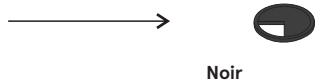

Noir

Piètement - métal

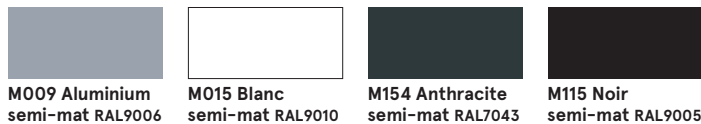

* corps - groupe II

Ogi W

descriptif technique



.mdd

MDD, créée en 1993 à Sępólno Krajeńskie en Pologne, est d'abord une histoire d'amitié entre Jaroslaw DABROWSKI et Zbigniew MATTYA.

Depuis l'origine, nous souhaitons incarner un modèle d'entreprise où l'humain est la première des préoccupations. Nous considérons que l'épanouissement personnel de chaque membre de notre équipe, est la clé de notre succès. Garder comme piliers des valeurs familiales participe à ce projet.

Nous créons du mobilier répondant aux besoins spécifiques des espaces de travail. Pour vous permettre de favoriser le travail collaboratif, la créativité et les échanges dans l'entreprise, nous vous proposons un mobilier design, conçu PAR et POUR l'homme. Grâce à notre politique de réinvestissement constant dans l'outil de production nous disposons d'un parc de machines modernes, permettant une fabrication de qualité. Citoyens du monde, nous agissons aujourd'hui en pensant aux générations de demain. Ainsi nous utilisons des matériaux au taux de recyclabilité proche de 95%.

Le monde du travail est en mutation constante. Nous veillons, et collaborons avec des designers et nos clients, pour anticiper et être toujours au plus près du besoin.



Informations générales :

Garantie :

Produits MDD - **5 ans**.

Composants électriques et tissus - **2 ans**.

Méla miné - certifié :



Montage :

livrée en pièces détachées

Emballage :

carton, enveloppe en plastique perforé

Conforme aux normes :

PN-EN 527-2:2017-02

Densité du panneau :

12 mm - 690 - 750 kg/m³

18 mm - 650 - 690 kg/m³

28 mm - 610 - 630 kg/m³

36 mm - 610 - 630 kg/m³

Plateaux bureaux Ogi

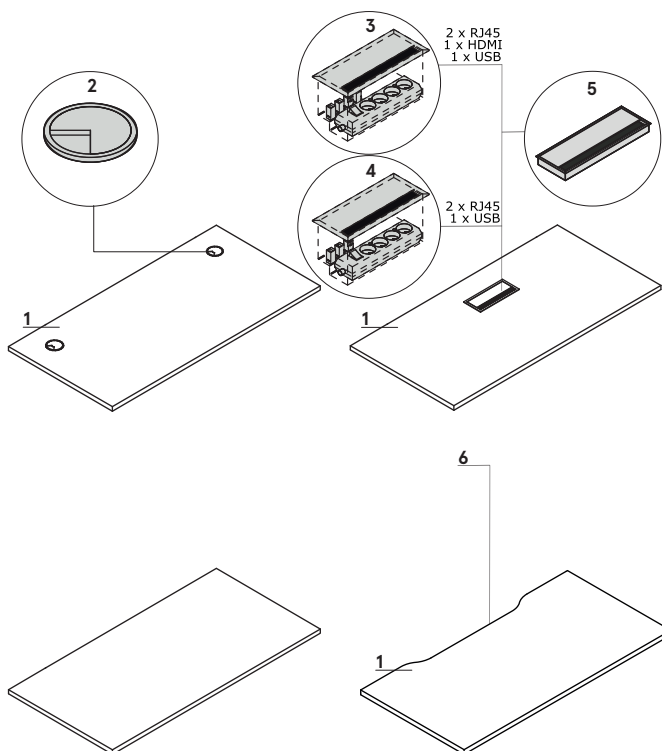

1. Plateau - mélaminé 28 mm, chants ABS

OPTION PAYANTE:

2. Obturateurs - 2 pcs, Ø 80 mm

3. Mediabox M04H - 2xRJ45 (classe E, cat. 6); 1xUSB/1xHDMI/4x230V, couleur: M009 - aluminium semi-mate

4. Mediabox M04 - 2xRJ45 (classe E, cat. 6); + 1 x USB + 4 x 230V, couleur: M009 - aluminium semi-mate

5. Top access M05 - couleur: M009 - aluminium semi-mate

6. Passage de câbles - la largeur de l'ouverture est proportionnelle à la largeur du plan de travail

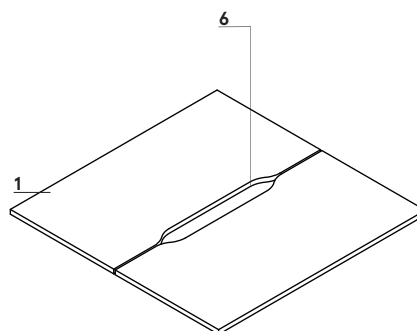

Dimensions du plateau avec découpe pour passage de câbles (mm)

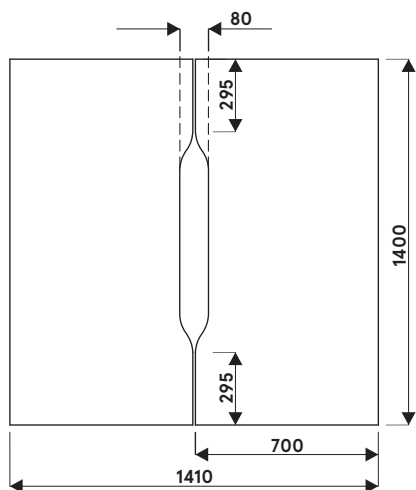

Ogi W	Date 18.11.2019	Ces données sont valides à la date d'élaboration. Les évolutions des produits, si elles ne touchent pas les caractéristiques fondamentales, n'impliquent pas une mise à jour systématique de la fiche technique.	page 3/9 descriptif et composition
-------	--------------------	---	---------------------------------------

Piétement

Ogi W: Pied en bois de frêne naturel, profil 40 × 40 mm, avec éléments en métal finition poudre époxy, espace entre le plateau et le cadre de 10 mm

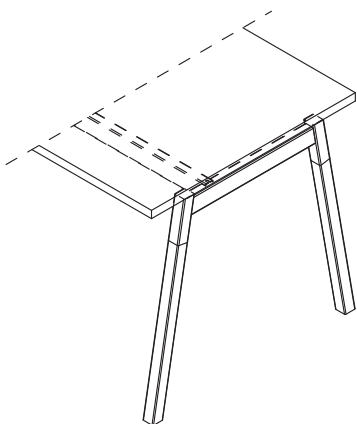

Bureaux manager sur meuble retour porteur

- 1. Plateau - mélaminé 28 mm, chants ABS
- 2. Top - mélaminé 28 mm, chants ABS
- 3. Tablette - mélaminé 18 mm, protection contre les chutes accidentelles, chants ABS
- 4. Tiroir - mélaminé 18 mm; chants ABS, serrure, possibilité de le changer de place
- 5. Base - mélaminé 18 mm, chants ABS
- 6. Façade - mélaminé 18 mm, chants ABS

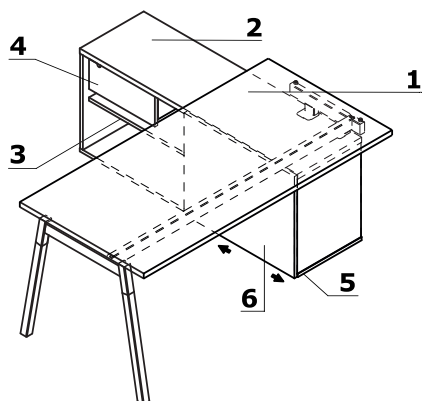

www.mdd.eu

Exemples de configurations (mm)

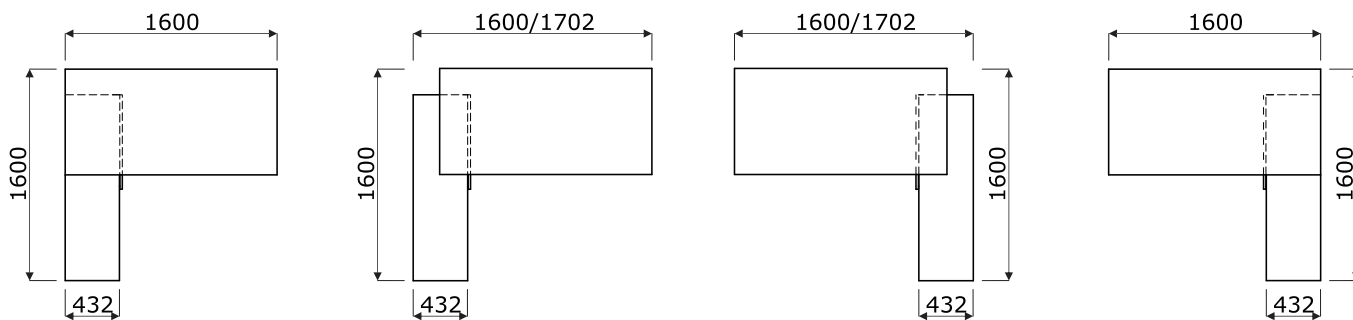

Exemples de configurations (mm)

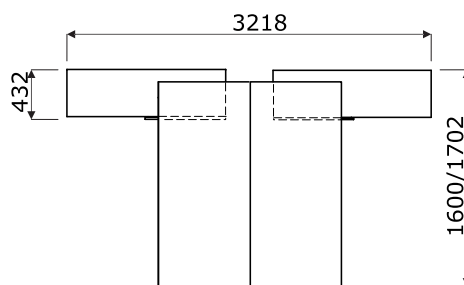
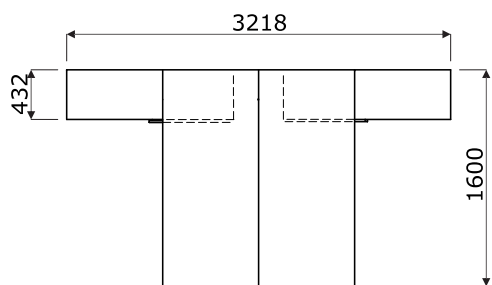

Exemples de configuration avec BOX40, BOX50, BOX60

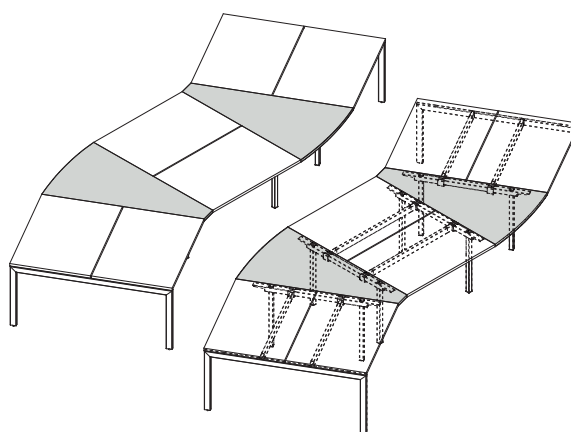
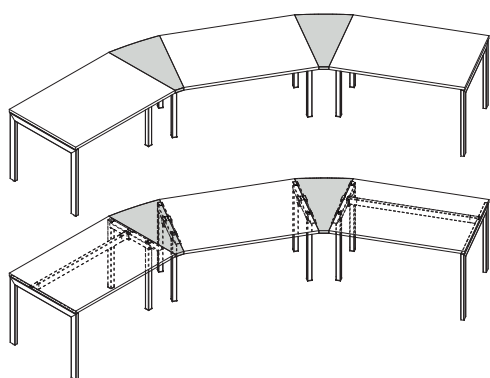

REMARQUE - Uniquement pour les systèmes Ogi Q, Ogi U, Ogi Y, Ogi W, Ogi M

Accessoires

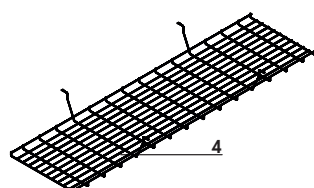
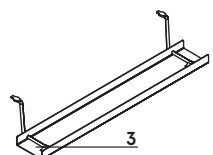
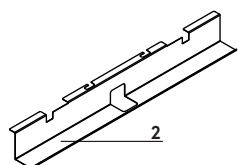
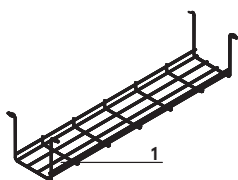

1. **Chemin de câbles S69** - métal finition peinture poudre époxy, couleur 09 - aluminium
2. **Chemin de câbles (SG12, SG16)** - pour bureau individuel, métal finition peinture poudre époxy, couleur M009 - aluminium semi-mate
3. **Chemin de câbles E64** - métal finition peinture poudre époxy, couleur M009 - aluminium semi-mate
4. **Chemin de câbles pour bench Ogi (SG220, SG260)** - fil acier Ø4 mm, métal finition peinture poudre époxy, couleur : 09 - aluminium

Bureaux droits



BOW22
1200 / 700 / 740
28.9 kg



BOW24
1400 / 700 / 740
32.3 kg



BOW26
1600 / 700 / 740
35.9 kg

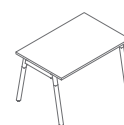

BOW02
1200 / 800 / 740
34.8 kg



BOW03
1400 / 800 / 740
35.3 kg



BOW04
1600 / 800 / 740
35.9 kg



BOW05
1800 / 800 / 740
39 kg



BOW06
2000 / 800 / 740
45.3kg



BOW07
2000 / 1000 / 740
49.5 kg

www.mdd.eu

Élément suivant - pour bureau droit



BOX40
500 / 800 / 740
10.8 kg

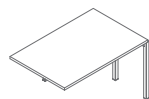

BOX42
1200 / 800 / 740
31.6 kg

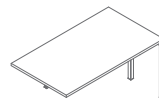

BOX43
1400 / 800 / 740
32.1 kg

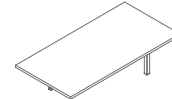

BOX44
1600 / 800 / 740
32.7 kg

Élément suivant - pour bureau droit

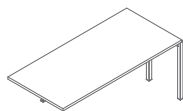

BOX45
1600 / 800 / 740
35.8 kg

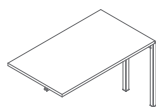

BOX32
1200 / 700 / 740
26.3 kg

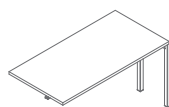

BOX34
1400 / 700 / 740
29.7 kg

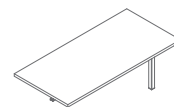

BOX36
1600 / 700 / 740
33.3 kg

Benchs

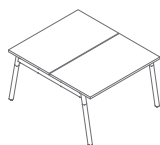

BOW42
1200 / 1410 / 740
53.8 kg

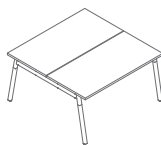

BOW44
1400 / 1410 / 740
60.6 kg

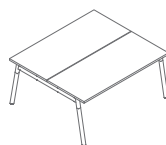

BOW46
1600 / 1410 / 740
67.8 kg



BOW32
1200 / 1610 / 740
64.6 kg

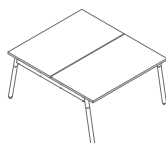

BOW33
1400 / 1610 / 740
65.6 kg

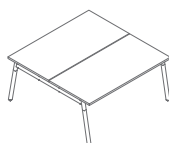

BOW34
1600 / 1610 / 740
66.8 kg

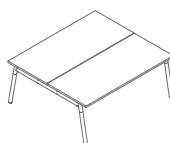

BOW35
1800 / 1610 / 740
73 kg

Élément de jonction et élément suivant - pour bench

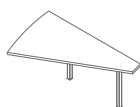

BOX50
1000 / 1410 / 740
16.5 kg

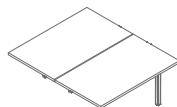

BOX52
1200 / 1410 / 740
49.4 kg

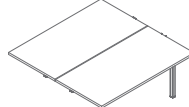

BOX54
1400 / 1410 / 740
56.2 kg

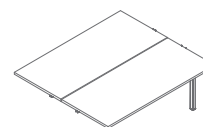

BOX56
1600 / 1410 / 740
63.4 kg

Élément de jonction et élément suivant - pour bench



BOX60
1000 / 1610 / 740
17,5 kg

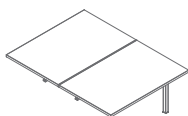

BOX62
1200 / 1610 / 740
60.1 kg

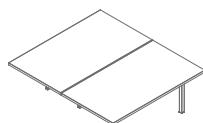

BOX64
1400 / 1610 / 740
61.1 kg

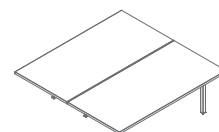

BOX66
1600 / 1610 / 740
62.3 kg

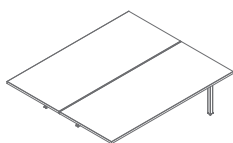

BOX68
1800 / 1610 / 740
68,5 kg

Bureaux sur meuble retour porteur

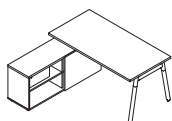

BOW20
1702-1600 / 1600 / 740
92 kg

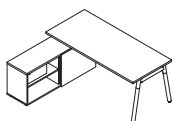

BOW21
1902-1800 / 1600 / 740
93,5 kg

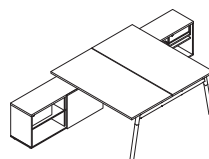

BOW40
1702-1600 / 3210 / 740
178.8 kg

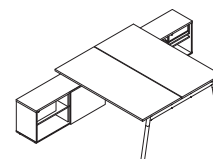

BOW41
1902-1800 / 3210 / 740
185 kg

Retours / extensions

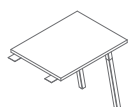

PLW01
600 / 800 / 740
13,3 kg

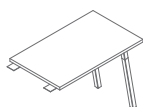

PLW02
600 / 1000 / 740
14,8 kg

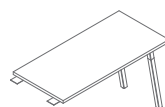

PLW03
600 / 1200 / 740
17,3 kg

Plateau, top, base, corps, façade



14 Hêtre 26 Aluminium satiné 31 Chêne canadien 39 Bouleau clair

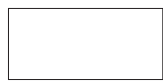

67 Blanc pastel



34 Wengé 64 Cacao 106 Noyer 154 Anthracite



08 Noir

Passes câbles

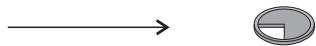

Aluminium

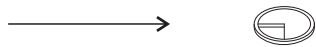

Blanc

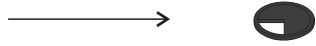

Noir

Piètement - métal



M009 Aluminium semi-mat RAL9006 M015 Blanc semi-mat RAL9010 M154 Anthracite semi-mat RAL7043 M115 Noir semi-mat RAL9005

Pied - contre-plaqué



Frêne naturel

* corps - groupe II
 ** OPTION AVEC PLUS VALUE - chants du plateau, coloris : frêne naturel
 *** la couleur des pieds du bureau peut varier du fait qu'ils sont en bois naturel