

---

# Guest

---

**Family**

Armchair / Sofa / Ottoman /  
System

---

**Designer**

Antonio Rodriguez / 2015

---

**Link**

[www.read-mo.re/guest](http://www.read-mo.re/guest)



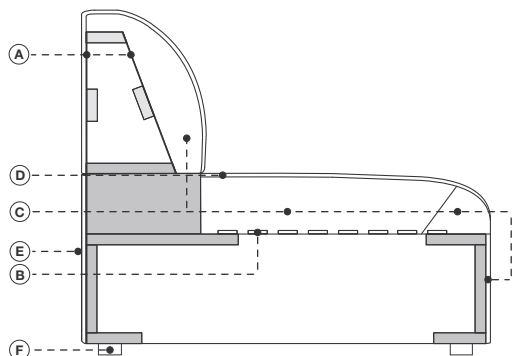

- Legno massiccio di abete
- Legno massiccio di faggio
- A.** Pannello di masonite
- B.** Cinghie elastiche ad alta densità
- C.** Poliuretano espanso ignifugo indeformabile a quote differenziate
- D.** Fibra di poliestere
- E.** Rivestimento fisso in tessuto o pelle
- F.** Polipropilene nero

- Solid fir
- Solid beech
- A.** Masonite panels
- B.** High density elastic straps
- C.** Flame-retardant undeformable polyurethane foam of different densities
- D.** Polyester fibers
- E.** Fixed upholstery in fabric or leather
- F.** Black polypropylene

- Bois de sapin massif
- Bois de hêtre massif
- A.** Panneau de particules
- B.** Sangles élastiques
- C.** Mousse polyuréthane expansé ignifuge indéformable à épaisseurs différenciées
- D.** Fibre de polyester
- G.** Revêtement pas déhoussable en tissu ou cuir
- F.** Polypropylène noir

- Massivholz aus Tanne
- Massivholz aus Buche
- A.** Holzfaserplatte
- B.** Elastischen Gurtbändern
- C.** Feuerfester formbeständige Polyurethanschaum in unterschiedlicher Dichte
- D.** Polyester
- E.** Unabziehbarer Bezug aus Stoff oder Leder
- F.** Schwarz Polypropylen

Note · Notes · Annotation · Anmerkung

- Prodotto disponibile su misura con preventivo su richiesta
- Su richiesta attacco per connessione elettrica e USB con sovrapprezzo
- Cuscini extra disponibili
- COM: tessuto cliente (tinta unita e h.140 cm.) - campione richiesto
- COL: pelle cliente - campione richiesto
- CAT. SPECIAL: prezzo e disponibilità su richiesta
- This item can be tailor made with price on request
- Electrical connection and USB upon request with upcharge
- Extra cushions available
- COM: client's fabric (plain colour and width 140 cm.) - sample required
- COL: client's leather - sample required
- CAT. SPECIAL: price and availability upon request
- Collection personnalisable sur demande
- Sur demande connection électrique et USB avec surcoût
- Autres coussins disponibles
- COM: tissu fourni (couleur unie et hauteur 140 cm.) - échantillon nécessaire
- COL: cuir fourni - échantillon nécessaire
- CAT. SPECIAL: prix et disponibilité sur demande
- Produkt nach Maß verfügbar auf Anfrage
- Elektrische Verbindung und USB-Anschluss auf Anfrage gegen Aufpreis
- Weitere Kissen verfügbar
- COM: Kundenstoff (einfarbig und Breite 140 cm.) - Stoffmuster nötig
- COL: Kundenleder - Ledermuster nötig
- CAT. SPECIAL: Preis und Verfügbarkeit auf Anfrage

Opzione · Option · Option · Opzion



Su richiesta attacco per connessione elettrica e USB con sovrapprezzo  
 Electrical connection and USB upon request with upcharge  
 Sur demande connection électrique et USB avec surcoût  
 Elektrische Verbindung und USB-Anschluss auf Anfrage gegen Aufpreis

Sistema di aggancio · System connector · Systeme d'assemblage · Verbindungshaken



Sistema di aggancio tra elementi  
 Components connector  
 Systeme d'assemblage de socle  
 Verbindungssystem zwischen Elemente

Rivestimenti consigliati · Recommended coverings · Revêtements conseillées · Empfohlene Bezüge

- |          |                |              |               |              |                 |                 |            |
|----------|----------------|--------------|---------------|--------------|-----------------|-----------------|------------|
| • cat. A | XTREME         | • cat. C     | TREND         | • cat. extra | MOLLY           | • cat. lux      | LUX 1      |
| • cat. A | STEP           | • cat. C     | SUPERB        | • cat. extra | RIME            | • cat. lux      | LUX 2      |
| • cat. A | ANGEL          | • cat. C     | HESTAN        | • cat. extra | STEELCUT TRIO 3 | • cat. imperial | IMPERIAL 1 |
| • cat. A | MEDLEY         | • cat. C     | DEANS         | • cat. extra | ARIANA          | • cat. imperial | IMPERIAL 2 |
| • cat. A | MOOD           | • cat. super | REMIX 3       | • cat. extra | COLLINE         | • cat. imperial | NABUK      |
| • cat. A | CRAZY          | • cat. super | CAPTURE       | • cat. extra | OPERA           | • cat. special  | DROP       |
| • cat. B | EXTREMA        | • cat. super | MODA          | • cat. extra | DANTE           |                 |            |
| • cat. B | IKON           | • cat. super | REVIVE 1      | • cat. extra | ARCO            |                 |            |
| • cat. B | SILVERTEX      | • cat. super | BREEZE FUSION | • cat. maxi  | MOSAIC 2        |                 |            |
| • cat. B | SAMAR          |              |               | • cat. maxi  | HALLINGDAL 65   |                 |            |
| • cat. B | FAME           |              |               | • cat. maxi  | COMFORT         |                 |            |
| • cat. B | MAIN LINE FLAX |              |               | • cat. maxi  | DIVINA 3        |                 |            |

# GUEST

cod. 9000 / **armchair**

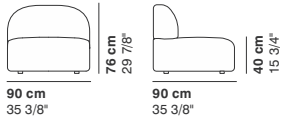

cod. 9001 / **2 seater**

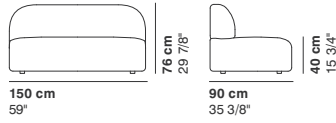

cod. 9002 / **2 seater major**

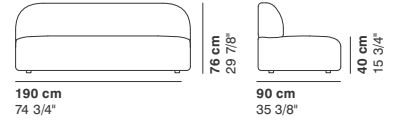

cod. 9003 / **3 seater**

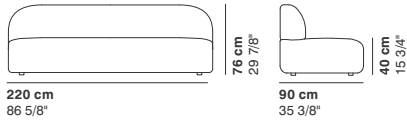

cod. 9004 / **right peninsula**

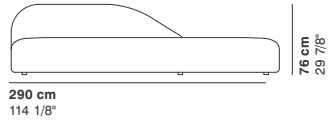

cod. 9005 / **left peninsula**

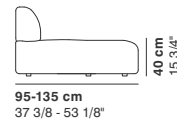
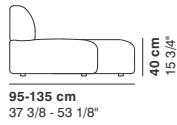
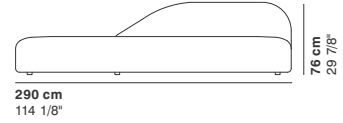

cod. 9025 / **small right peninsula**

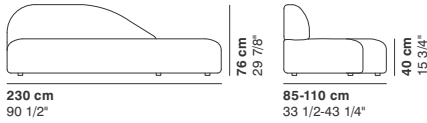

cod. 9026 / **small left peninsula**

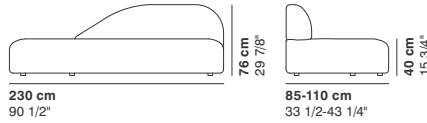

cod. 9006 / **element 100**

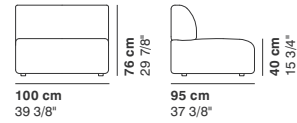

cod. 9007 / **element 150**

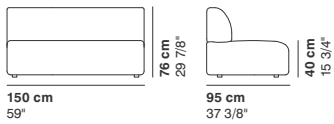

cod. 9008 / **element 200**

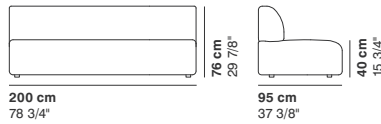

cod. 9009 / **right element 150**

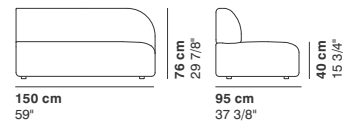

cod. 9010 / **left element 150**

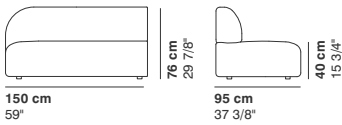

cod. 9011 / **right element 200**

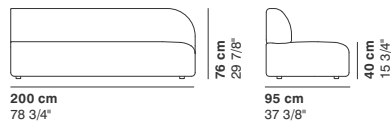

cod. 9012 / **left element 200**

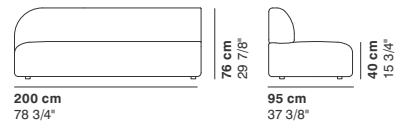

# GUEST

cod. 9013 / right element peninsula

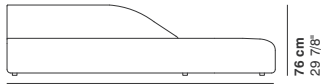

290 cm  
114 1/8"

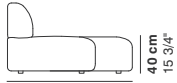

95-135 cm  
37 3/8"- 53 1/8"

cod. 9014 / left element peninsula

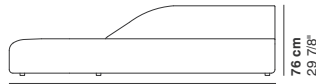

290 cm  
114 1/8"

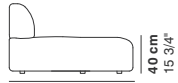

95-135 cm  
37 3/8"- 53 1/8"

cod. 9015 / open element curved 100

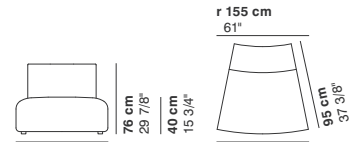

100 cm  
39 3/8"

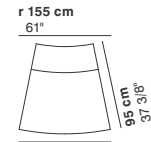

R 250 cm  
98 3/8"

cod. 9016 / closed element curved 100

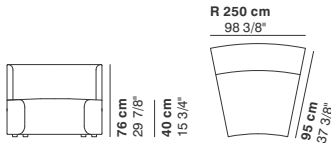

100 cm  
39 3/8"

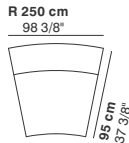

R 250 cm  
98 3/8"

cod. 9017 / open element curved 200

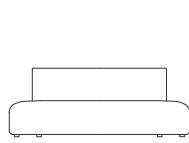

200 cm  
78 3/4"

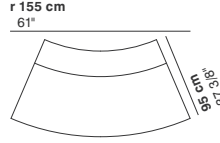

R 250 cm  
98 3/8"

cod. 9018 / closed element curved 200

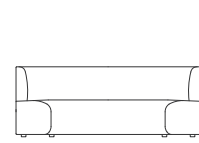

200 cm  
78 3/4"

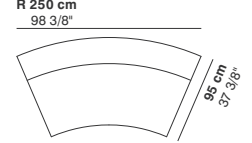

R 250 cm  
98 3/8"

cod. 9019 / ottoman diam.70

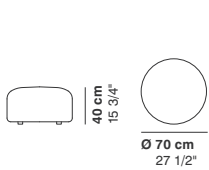

40 cm  
15 3/4"

Ø 70 cm  
27 1/2"

cod. 9020 / ottoman diam.100

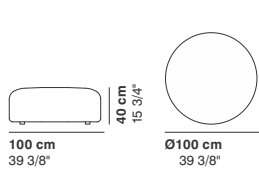

100 cm  
39 3/8"

40 cm  
15 3/4"

Ø 100 cm  
39 3/8"

cod. 9021 / ottoman diam.130

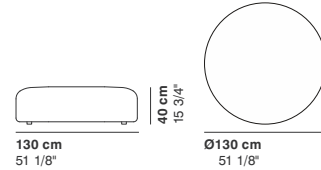

130 cm  
51 1/8"

40 cm  
15 3/4"

Ø 130 cm  
51 1/8"

# GUEST

## cod. GUE01 / composition

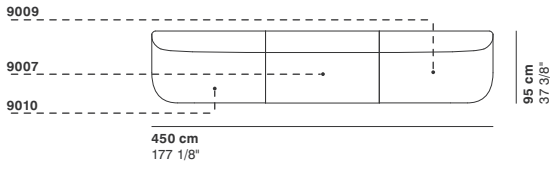

## cod. GUE02 / composition

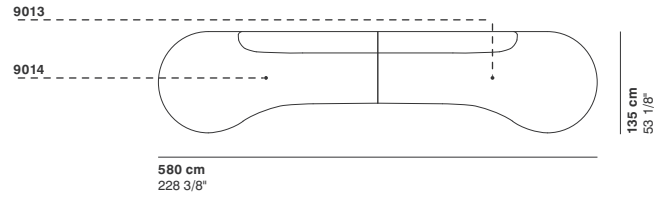

## cod. GUE03 / composition

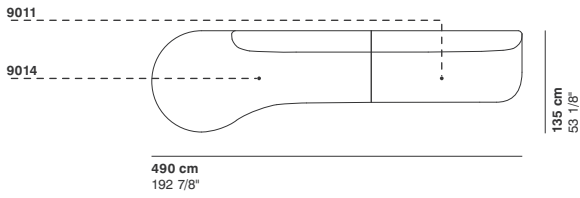

## cod. GUE04 / composition

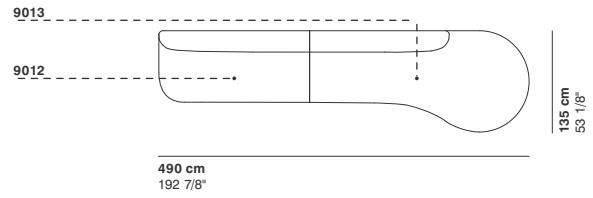

## cod. GUE05 / composition

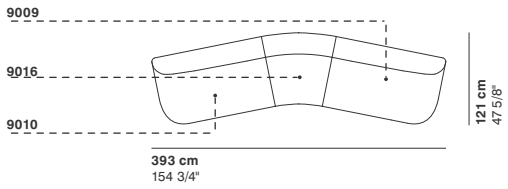

## cod. GUE06 / composition

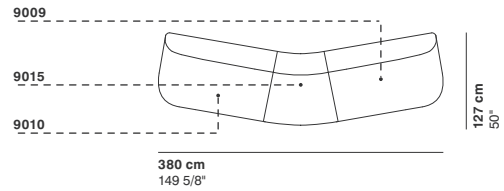

## cod. GUE07 / composition

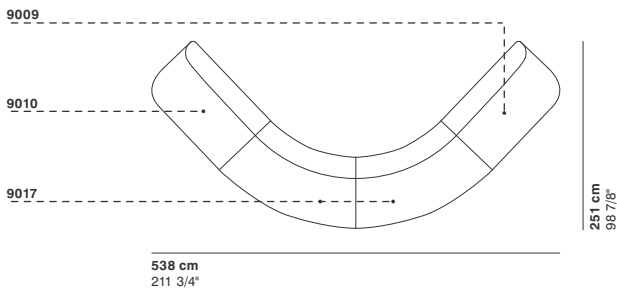

## cod. GUE08 / composition

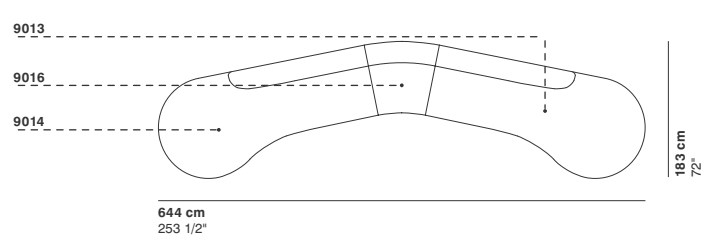

La Cividina s.r.l., al fine di migliorare caratteristiche tecniche e qualitative della sua produzione, si riserva di apportare, anche senza preavviso, tutte le modifiche che si rendessero necessarie.

With a view to improving the technical characteristics and quality of its products, La Cividina s.r.l. reserves the right to develop its products at anytime without notice.

Afin d'améliorer les caractéristiques techniques et qualitatives de sa production, La Cividina s.r.l. se réserve d'apporter, même sans préavis, toutes les modifications qui se rendront nécessaires.

Zur Verbesserung der technischen und qualitativen Merkmale, behält sich La Cividina s.r.l. vor, alle notwendig erscheinenden Produktionsänderungen, auch ohne Vorankündigung durchzuführen.



ISO 9001

**LaCividina srl**

**HEADQUARTERS  
/ PRODUCTION**

Via Cividina 176  
33035 Martignacco  
Udine Italy

**SHOWROOM**

Via Lungolavia 1  
33035 Martignacco  
Udine Italy

T. + 39 0432 677433

F. + 39 0432 677480

info@lacividina.com

www.lacividina.com

VAT nr. IT01810870301